

ORIGINAL

THE

OE-DHU

S.N. 28-7415449

Cherokee WARRIOR

DUPLICATE

PILOT'S OPERATING MANUAL



BY



This manual is incomplete without an APPROPRIATE
FLIGHT MANUAL and an APPROPRIATE

PLANE
PORT.

WARNING

EXTREME CARE MUST BE EXERCISED TO LIMIT THE USE OF THIS MANUAL TO APPLICABLE AIRCRAFT. THIS MANUAL REVISED AS INDICATED BELOW OR SUBSEQUENTLY REVISED IS VALID FOR USE WITH THE AIRPLANE IDENTIFIED BELOW WHEN APPROVED BY PIPER AIRCRAFT CORPORATION. SUBSEQUENT REVISIONS SUPPLIED BY PIPER AIRCRAFT CORPORATION MUST BE PROPERLY INSERTED.

MODEL PA-28-151

AIRCRAFT SERIAL NO. 28-7415449 REGISTRATION NO. _____

PILOT'S OPERATING MANUAL, PART NUMBER 761 563 REVISION 14

**PIPER AIRCRAFT CORPORATION
APPROVAL SIGNATURE AND STAMP**

Anne M. Boyer
Anne M. Boyer

Assurance that the airplane is in an airworthy condition is the responsibility of the owner. The pilot in command is responsible for determining that the airplane is safe for flight. The pilot is also responsible for remaining within the operating limitations outlined by the Airplane Flight Manual, instrument markings, and placards.

This Pilot's Operating Manual is not designed as a substitute for adequate and competent flight instruction, knowledge of the current airworthiness directives, applicable federal air regulations, or advisory circulars. It is not intended to be a guide for basic flight instruction or a training manual for transition from single to multi-engine flying.

If an inconsistency of information exists between the Pilot's Operating Manual and the Airplane Flight Manual approved by the FAA, the Airplane Flight Manual shall be the authority.

A complete or partial replacement of this manual, Part No. 761 563, may be obtained only from Piper Customer Services.

Published by
PUBLICATIONS DEPARTMENT
Piper Aircraft Corporation
761 563
Issued: July 1973

APPLICABILITY

This manual is applicable to Piper Model PA-28-151 aircraft having serial numbers 28-7415001 through 28-7615435. Contact Piper Customer Services for specific information on the application of this manual.

REVISIONS

The information compiled in the Pilot's Operating Manual will be kept current by revisions distributed to the airplane owners.

Revision material will consist of information necessary to update the text of the present manual and/or to add information to cover added airplane equipment.

I. Revisions

Revisions will be distributed whenever necessary as complete page replacements or additions and shall be inserted into the manual in accordance with the instructions given below:

1. Revision pages will replace only pages with the same page number.
2. Insert all additional pages in proper numerical order within each section.
3. Page numbers followed by a small letter shall be inserted in direct sequence with the same common numbered page.

II. Identification of Revised Material

Revised text and illustrations shall be indicated by a black vertical line along the left hand margin of the page, opposite revised, added or deleted material. A line opposite the page number or section title and printing date, will indicate that the text or illustration was unchanged but material was relocated to a different page or that an entire page was added.

Black lines will indicate only current revisions with changes and additions to or deletions of existing text and illustrations. Changes in capitalization, spelling, punctuation or the physical location of material on a page will not be identified by symbols.

III. Original Pages Issued

The original pages issued for this manual prior to revision are given below:

1-1 through 1-3, 2-1 through 2-19, 3-1 through 3-12, 4-1 through 4-6, 5-1 through 5-28, 7-1 through 7-10, 8-1 through 8-2, 9-1 through 9-12, 10-1 through 10-17.

PILOT'S OPERATING MANUAL LOG OF REVISIONS

Current Revisions to the PA-28-151 Cherokee Warrior Pilot's Operating Manual, 761 563, issued July 17, 1973.

Revision	Revised Pages	Description	Date
Rev. 1 - 761 563 (PR730801)	AFM	Added Rev. 1 to Report VB-573	Aug. 1, 1973
Rev. 2 - 761 563 (PR730830)	AFM W/B	Added Rev. 2 to Report VB-573 Added Rev. 1 to Report VB-535	Aug. 30, 1973
Rev. 3 - 761 563 (PR740125)	1-1 2-10 4-6 W/B 7-i 7-5 7-9 7-10 7-11 8-1 9-2	Revised Weights Revised overvoltage relay reset time. Revised Alternator Failure Item 3. Added Rev. 2 to Report VB-535 Added Airspeed Data; revised ELT. Revised Takeoff - Short Field, Soft Field Added Airspeed Data; relocated ELT to Page 7-10. Added ELT from Page 7-9; moved info to Page 7-11. Added Page. Revised Item 6. Revised Takeoff Distance Vs Density Attitude Chart.	Jan. 25, 1974
Rev. 4 - 761 563 (PR740531)	ii iii A F/M W/B	Added PAC Approval Form. Added Applicability and Item III. Original Pages Issued. Added Rev. 3 to Report: VB-573. Added Rev. 3 to Report: VB-535. (NOTE: AIRCRAFT DELIVERED WITH MANUALS PRIOR TO THIS REVISION DO NOT REQUIRE THIS REVISION.)	May 31, 1974
Rev. 5 - 761 563 (PR740614)	1-2 2-10 2-11 2-11a 2-12 2-12a 2-13 2-14 A F/M W/B	Revised Dimensions; revised Wheel Base. Added annunciator panel and footnote. Revised Alternator and Starter Schematic. Added Alternator Starter Schematic. Relocated Circuit Breaker Panel illustration. Added page. Added Annunciator Panel information and footnote. Revised instrument panel illustration. Added Rev. 4 to Report VB-573. Added Rev. 3 to Report VB-535.	June 14, 1974

PILOT'S OPERATING MANUAL LOG OF REVISIONS (cont)

Revision	Revised Pages	Description	Date
Rev. 5 (cont)	7-4	Added Annunciator Panel check to Ground Check; added footnote.	
	7-7	Revised Maneuvers info.	
	7-8	Added Maneuvers info; revised Approach and Landing info.	
	8-1	Revised Item 6; added footnote.	
	9-i	Revised Index.	
	9-2	Revised Takeoff Chart.	
	9-3	Revised Climb Chart.	
	9-4	Revised Engine Chart.	
	9-5	Revised Airspeed (Power) Chart.	
	9-6	Revised Airspeed (Economy) Chart.	
	9-7	Revised Range (Power) Chart.	
	9-8	Revised Range (Economy) Chart.	
	9-11	Revised Glide Chart.	
9-12	Revised Landing Chart.		
Rev. 6 - 761 563 (PR750117)	A F/M	Added Rev. 5 to Report VB-573.	Jan. 17, 1975
	W/B	Added Rev. 5 to Report VB-535.	
	7-10	Revised ELT info.	
	8-2	Added item 11.	
Rev. 7 - 761 563 (PR750714)	1-1	Revised Empty Weight and Useful Load.	July 14, 1975
	2-1	Deleted info. (AIRFRAME)	
	2-6	Revised aileron info; added centering spring effectivity.	
	2-7	Revised fuel tank info; added ser. no. eff.; added fuel manifold effectivity.	
	2-8	Added ser. nos. effectivity to illustration.	
	2-8a	Added page (fuel system illustration).	
	2-8b	Added page.	
	2-12	Added callout.	
	2-14	Added Engine Hour Meter; revised callouts.	
	A F/M	Added Rev. 6 to Report VB-573.	
	W/B	Added Rev. 6 to Report VB-535.	
	7-8	Revised Approach and Landing Flaps - set speed; added footnote.	
	7-9	Revised Airspeed Correction table.	
	8-1	Revised item 3 (Flap Speed); revised item 8 (Fuel Warning Tip); added footnote.	
10-9	Revised Draining Fuel Valve and Lines info; added fuel manifold effectivity.		
10-10	Revised Draining Fuel System info; added fuel manifold effectivity.		

PILOT'S OPERATING MANUAL LOG OF REVISION (cont)

Revision	Revised Pages	Description	Date
Rev. 8 - 761 563 (PR751201)	A F/M W/B 7-10	Added Rev. 7 to Report: VB-573. Added Rev. 7 to Report: VB-535. Revised ELT infor; relocated info to page 7-11.	Dec. 1, 1975
Rev. 9 - 761 563 (PR760416)	7-11 8-1 1-2 A F/M 7-5 7-6 7-8 8-2 10-i 10-9 10-10	Added info from page 7-10. Revised item 8. Revised Fuel Specifications. Added Rev. 8 to Report: VB-573. Added note. Revised Cruising info. Revised Approach and Landing item 5. Added items 12, 13 and 14. Revised page nos. for Filling Fuel Tanks, Draining Fuel Valves and Lines, Draining Fuel System and Tire Inflation. Revised Fuel Requirements; relocated Filling Fuel Tanks to page 10-10; revised Draining Fuel Valves and relocated to page 10-10. Added information from page 10-9 and revised and relocated Draining Fuel System to page 10-11; relocated	April 16, 1976
Rev. 11 - 761 563 (PR770603)	7-10 7-11 A F/M 7-3 7-11	Revised pilot's master switch description; added info from page 7-11; moved info to page 7-11. Added info from page 7-10; moved info to page 7-10. Added Rev. 9 to Report: VB-573. Revised Starting Engine When Flooded. Revised ELT Note.	June 3, 1977
Rev. 12 - 761 563 (PR771021)	iii A F/M W/B	Added Applicable Serial Numbers. Added Rev. 10 to Report: VB-573. Added Rev. 9 to Report: VB-535. (NOTE: AIRCRAFT DELIVERED WITH MANUALS PRIOR TO THIS REVISION DO NOT REQUIRE THIS REVISION.)	Oct. 21, 1977

PILOT'S OPERATING MANUAL LOG OF REVISIONS (cont)

Revision	Revised Pages	Description of Revision	Approved Date
Rev. 13 - 761 563 (PR790406)	2-9 2-10 2-15 W/B 7-10 10-11	Added Warning; relocated info. to pg. 2-10. Added info. from pg. 2-9. Added Caution. Added Rev. 10 to Report: VB-535. Revised ELT info. Added Caution.	April 6, 1979
Rev. 14 - 761 563 (PR881107)	AF/M W/B 7-3 9-ii 10-8 10-12	Added Rev. 11 to Report: VB-573. Added Rev. 11 to Report: VB-535. Revised Starting Engine When Hot and Starting Engine When Flooded. Added Warning. Revised Oil Requirements. Revised Facts You Should Know.	November 7, 1988

TABLE OF CONTENTS

GENERAL SPECIFICATIONS

DESCRIPTION - AIRPLANE AND SYSTEMS

AIRPLANE FLIGHT MANUAL F.A.A. APPROVED

EMERGENCY PROCEDURES F.A.A. APPROVED

EMERGENCY PROCEDURES

WEIGHT AND BALANCE

LOADING INSTRUCTIONS

OPERATING INSTRUCTIONS

OPERATING TIPS

PERFORMANCE CHARTS

HANDLING AND SERVICING

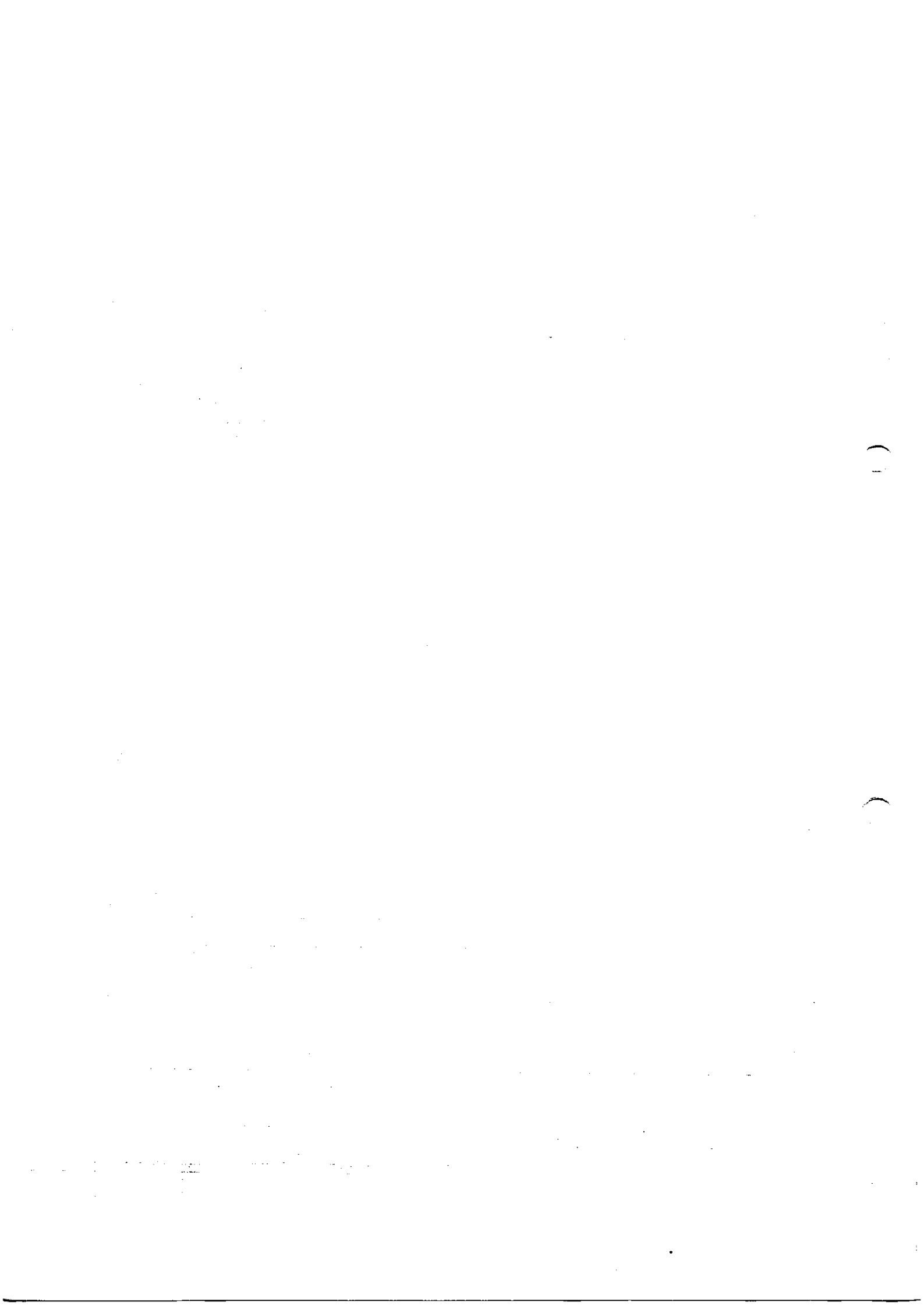

GENERAL SPECIFICATIONS

Performance	1-1
Weights	1-1
Power Plant	1-2
Fuel and Oil	1-2
Baggage	1-2
Dimensions	1-2
Landing Gear	1-2
3-View	1-3

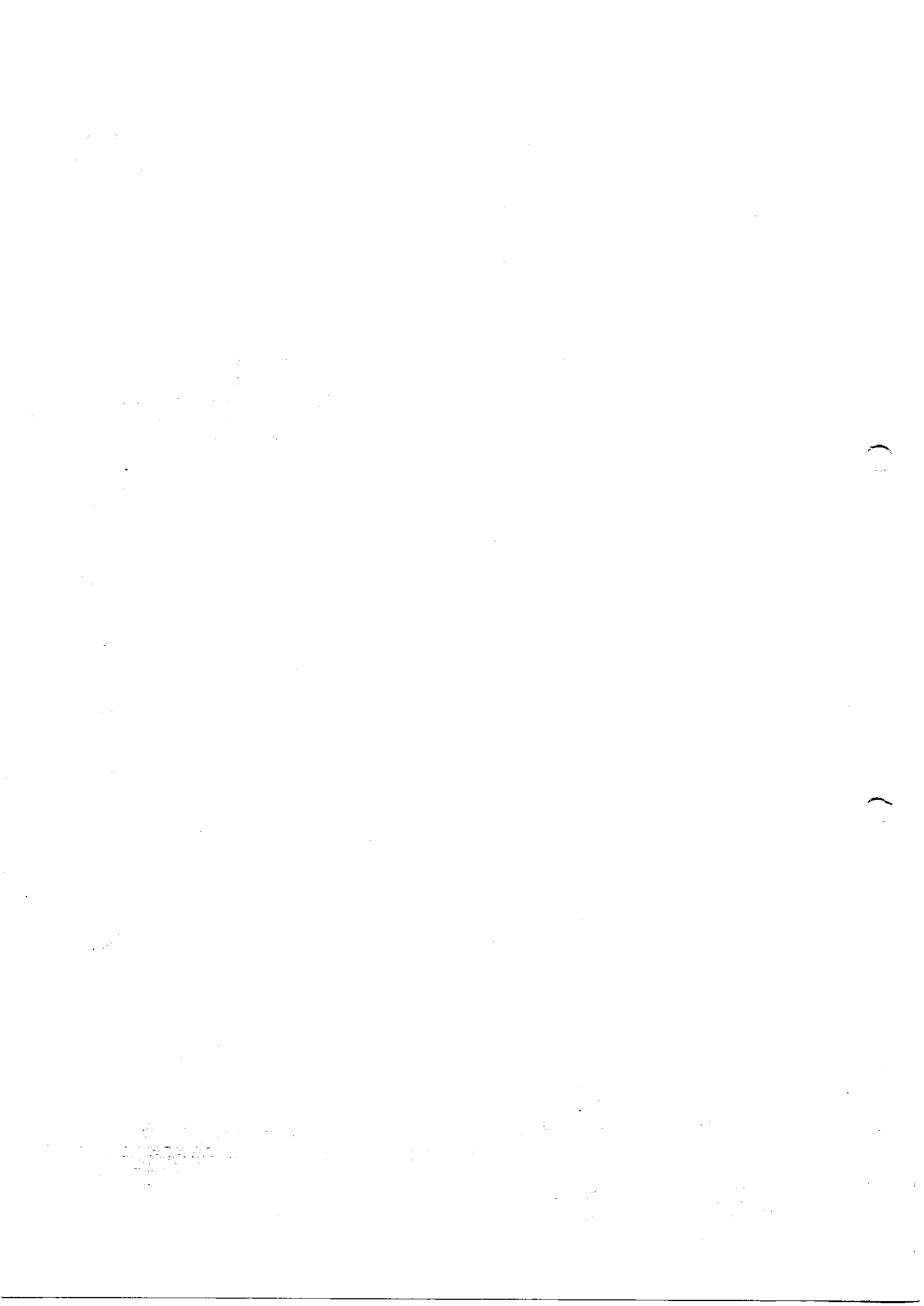

GENERAL SPECIFICATIONS

PERFORMANCE

Published figures are for standard airplanes flown at gross weight under standard conditions at sea level, unless otherwise stated. Performance for a specific airplane may vary from published figures depending upon the equipment installed, the condition of engine, airplane and equipment, atmospheric conditions and piloting technique. Each performance figure below is subject to the same conditions as on the corresponding performance chart from which it is taken in the Performance Charts Section.

Takeoff Ground Run (minimum) (ft)	1065
Takeoff Distance Over 50-ft Obstacle (25° flaps) (ft)	1760
Best Rate of Climb Speed (mph)	87
Rate of Climb (ft per min)	649
Service Ceiling (ft)	12,700
Absolute Ceiling (ft)	14,960
Top Speed (mph)	135*
Optimum Cruising Speed (75% power, optimum altitude, leaned to best power) (mph)	133*
Cruising Range (75% power, optimum altitude, leaned to best economy, no reserves) (mi)	720*
Optimum Cruising Range (55% power, optimum altitude, leaned to best economy, no reserves) (mi)	785*
Stalling Speed (flaps down) (mph)	58
Stalling Speed (flaps up) (mph)	64.5
Landing Roll (flaps down) (ft)	595
Landing Roll Over 50-ft Barrier (flaps down) (ft)	1115

WEIGHTS

Gross Weight (lbs)	2325
Standard Empty Weight (lbs)	1331
Maximum Useful Load (lbs)	994

*With Optional Wheel Fairings installed.

CHEROKEE WARRIOR

POWER PLANT

Engine (Lycoming)	O-320-E3D
Rated Horsepower	150
Rated Speed (rpm)	2700
Bore (inches)	5.125
Stroke (inches)	3.875
Displacement (cubic inches)	319.8
Compression Ratio	7:1
Dry Weight (pounds)	276
Propeller	
McCauley	1C160/EGM7653
Sensenich	74DM6-0-58

FUEL AND OIL

Fuel Capacity (U.S. gal) (standard)	50
Fuel Capacity (U.S. gal) Usable	48
Oil Capacity (qts)	8
Fuel, Aviation Grade	
Minimum Octane	80/87
Specified Octane	80/87
Alternate Fuels	Refer to Fuel Requirements, Section 10 - Page 10-9

DIMENSIONS

Wing Span (ft)	35
Wing Area (sq ft)	170.0
Length (ft)	23.8
Height (ft)	7.3
Wing Loading (lbs per sq ft)	13.7
Power Loading (lbs per hp)	15.5
Propeller Diameter (in.)	
McCauley	76
Sensenich	74
Turning Radius	13.0

BAGGAGE

Maximum Baggage (lbs)	200
Baggage Space (cubic ft)	24
Baggage Door Size (in.)	20 x 22

LANDING GEAR

Wheel Base (ft)	6.7
Wheel Tread (ft)	10.0
Tire Pressure (psi)	
Nose	30
Main	24
Tire Size	
Nose (4 ply rating)	5.00 x 5
Main (4 ply rating)	6.00 x 6

CHEROKEE WARRIOR

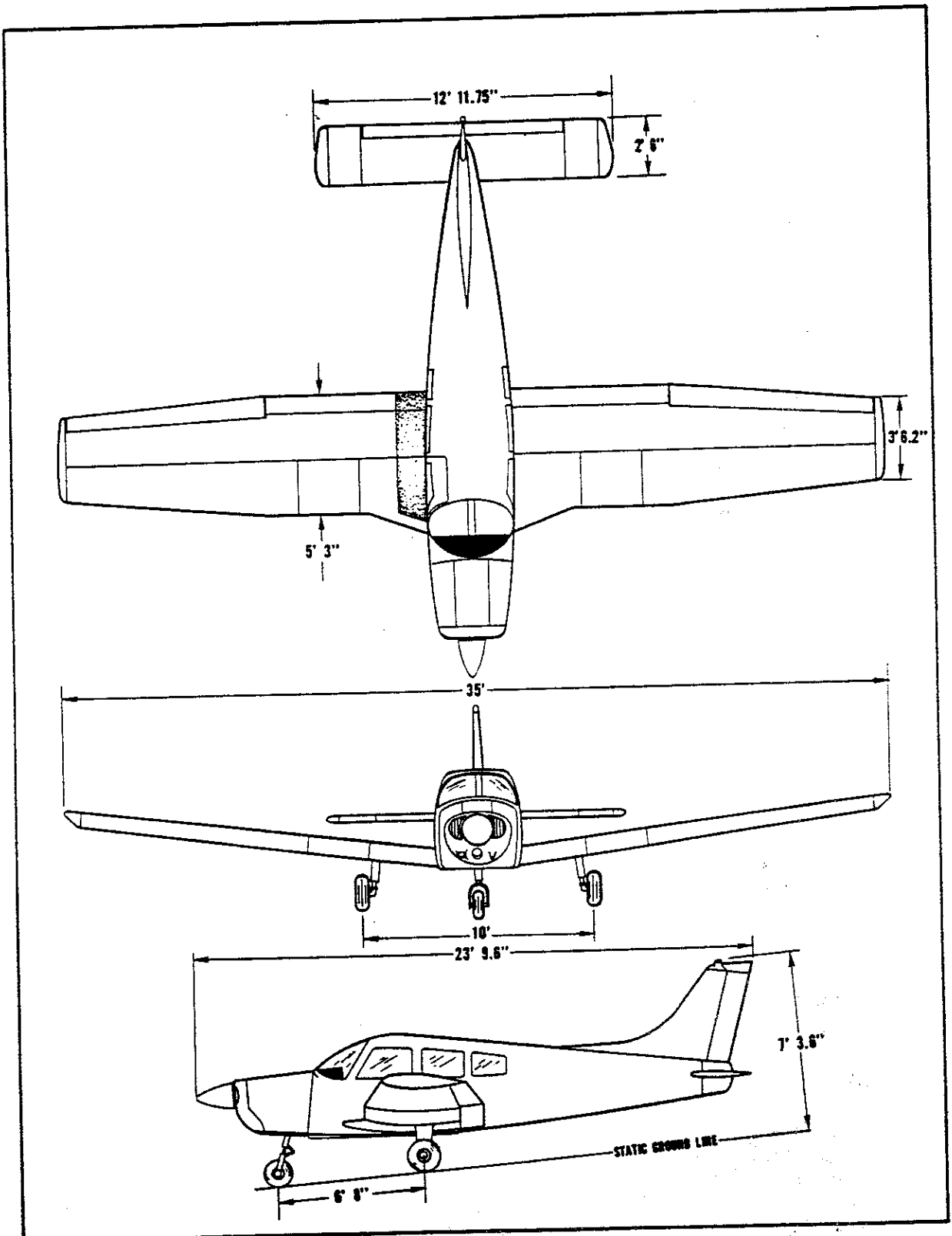

GENERAL SPECIFICATIONS
ISSUED: JULY 17, 1973

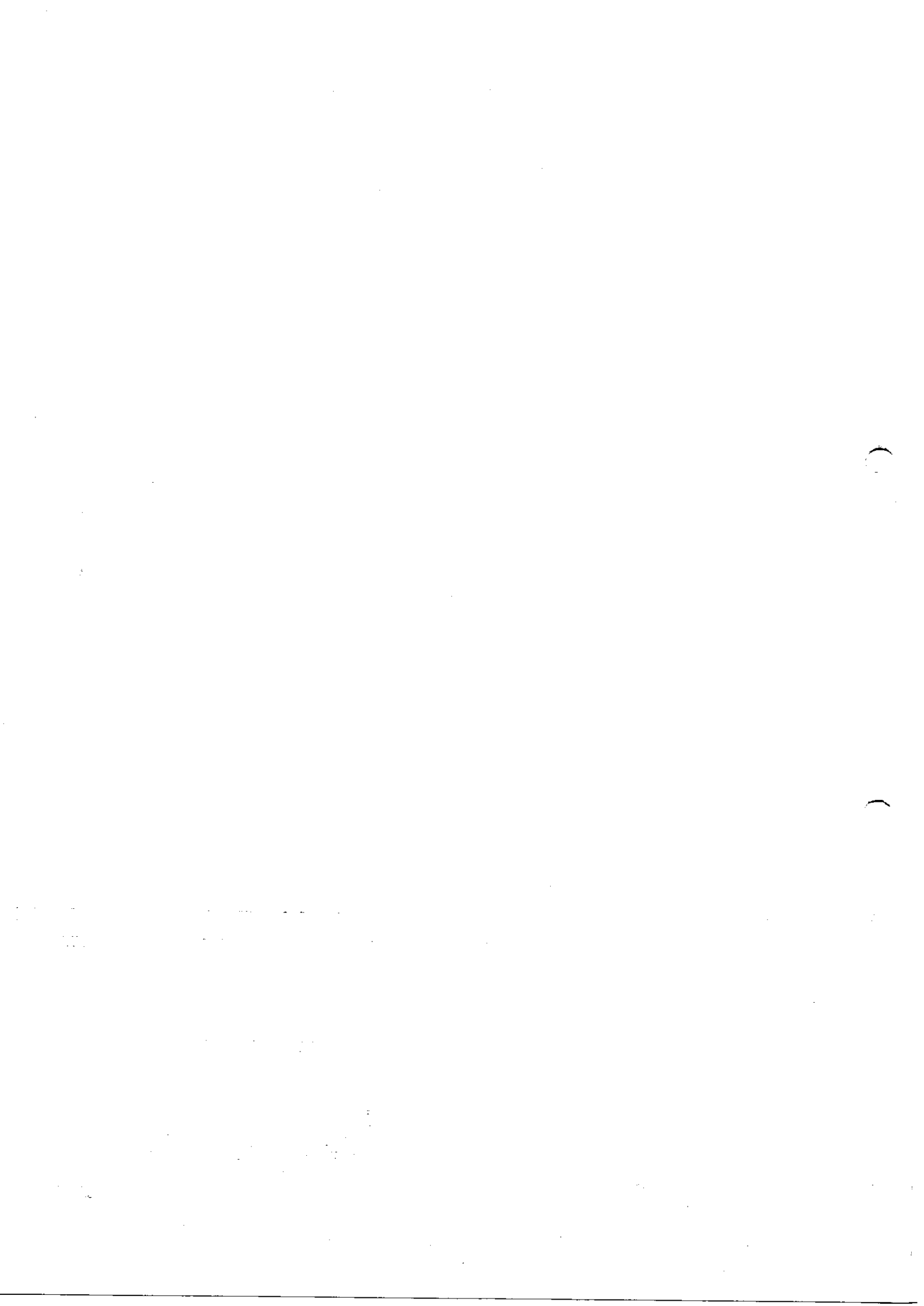

DESCRIPTION AIRPLANE AND SYSTEMS

The Airplane	2-1
Airframe	2-1
Engine and Propeller	2-2
Landing Gear	2-4
Flight Controls	2-6
Fuel System	2-7
Electrical System	2-9
Vacuum System	2-13
Instrument Panel	2-13
Pitot-Static System	2-15
Heating and Ventilating	2-15
Cabin Features	2-18
Baggage Area	2-18
Stall Warning	2-18
Finish	2-18
Emergency Locator Transmitter	2-19
Piper External Power	2-19

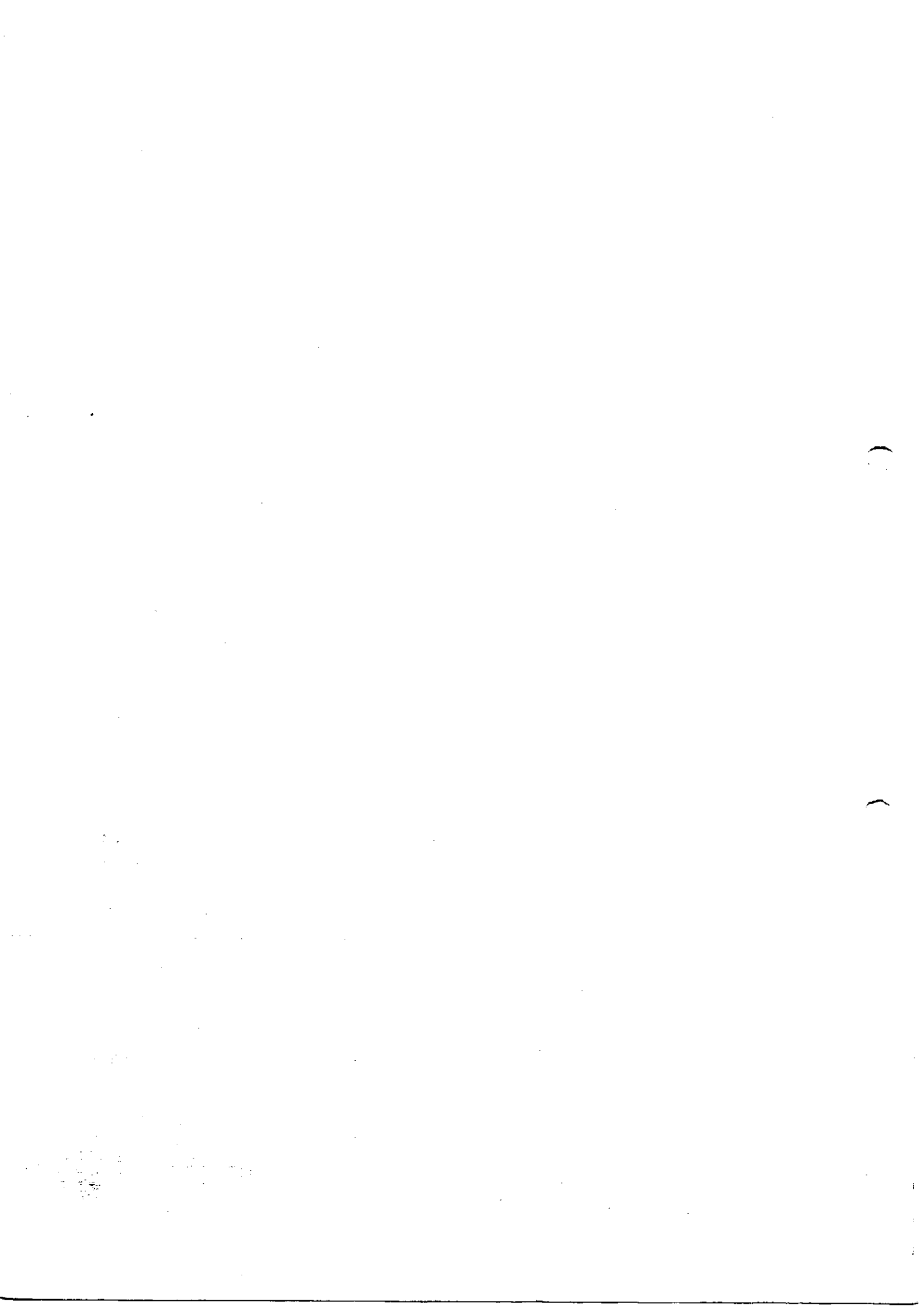

DESCRIPTION

AIRPLANE AND SYSTEMS

THE AIRPLANE

The Cherokee Warrior is a single-engine, fixed gear monoplane of all metal construction with low semi-tapered wings.

The fuselage provides a spacious, four-place interior with optional features to ensure individual comfort during short or extended cross-country flight.

The Cherokee Warrior can serve as a rental or cross-country airplane and also as a training and utility airplane. Performance and loading characteristics combine with economical operation to make the Warrior a versatile airplane in the business or personal aviation fields.

AIRFRAME

The primary structure, with the exception of the steel tube engine mount, steel landing gear struts and isolated areas, is of aluminum alloy construction. Tough fiberglass and thermoplastic are used extensively in the extremities - the wing tips, the engine cowling, etc. - and in nonstructural components throughout the airplane.

The fuselage is a conventional semi-monocoque structure. On the right side of the airplane is a large cabin door for ease of entrance and exit and a large baggage door to provide effortless loading into the 24 cubic foot compartment. Maintenance has been reduced to a minimum with advanced fuselage design.

The wing is a conventional semi-tapered design incorporating a laminar flow, NACA 65₂ 415, airfoil section. The cantilever wings are attached to each side of the fuselage by insertion of the butt ends of the main spars into a spar box carry-through which is an integral part of the fuselage structure. The spar box carry-through structure, located under the rear seat, provides in effect a continuous main spar with splices at each side of the fuselage. There are also fore and aft attachments at the rear and at an auxiliary front spar. This type of wing structure provides unobstructed cabin space for the rear passengers and allows for a lighter wing structure to improve the useful load of the airplane.

Both ailerons and flaps are of modern, all metal construction for smooth control of the aircraft. The ailerons are tapered to accommodate the semi-tapered wings. In the fully retracted position, the right flap locks to provide a step for cabin entry. The flaps have three extended positions: 10, 25, and 40 degrees.

A horizontal stabilator, vertical fin, and a rudder make up the empennage. They utilize a lightweight metal construction with fiberglass tips.

CHEROKEE WARRIOR

ENGINE AND PROPELLER

The PA-28-151 is powered by a Lycoming O-320-E3D four cylinder, direct drive, horizontally opposed engine rated at 150 HP at 2700 RPM. It is equipped with a starter, a 60 amp 14 volt alternator, a shielded ignition, dual magnetos, vacuum pump drive, a fuel pump, and a wetted polyurethane foam induction air filter. A recommended overhaul period of 2000 hours is based on Lycoming service experience. Operation beyond the recommended time is the decision of the operator. Since Lycoming from time to time revises the recommended overhaul period, the owner should check with his dealer for the latest overhaul period on his engine as well as any additional Lycoming Service Information.

The engine compartment is easily accessible for inspection through top-hinged side panels on either side of the engine cowlings. The engine cowlings are cantilever structures attached at the fire wall. The engine mounts are constructed of steel tubing, and dynafocal mounts are provided to reduce vibration.

The exhaust system is constructed of stainless steel and incorporates a single muffler with heater shrouds to supply heated air for the cabin, the defroster system and the carburetor deicing system.

An oil cooler is located on the left rear of the engine mounted to the engine baffling. Engine cooling air, which is picked up in the nose section of the engine cowling and carried through the baffling, is utilized on the left side for the oil cooler. A winterization plate is provided to restrict air during winter operation. (See Winterization in Handling and Servicing.)

Engine air enters on either side of the propeller through openings in the nose cowling and is carried through the engine baffling around the engine and oil cooler. Air for the muffler shroud is also picked up from the nose cowling and carried through a large duct to the shroud. Carburetor induction air enters a chin scoop on the lower right cowling and is passed through a wetted polyurethane filter to the carburetor air box. Heated air enters the carburetor air box through a hose connected to the heater shroud.

A McCauley 1C160/EGM7653 or a Sensenich 74DM6-0-58 fixed pitch propeller is installed as standard equipment. The McCauley propeller has a diameter of 76 inches with a pitch of 53 inches and the Sensenich has a 74 inch diameter with a 58 inch pitch. The pitch of both propellers is determined at 75% of the diameter. Both propeller units are of an aluminum alloy construction.

The pilot should read and follow the procedures recommended in the Lycoming Operator's Manual for this engine in order to obtain maximum engine efficiency and time between engine overhauls.

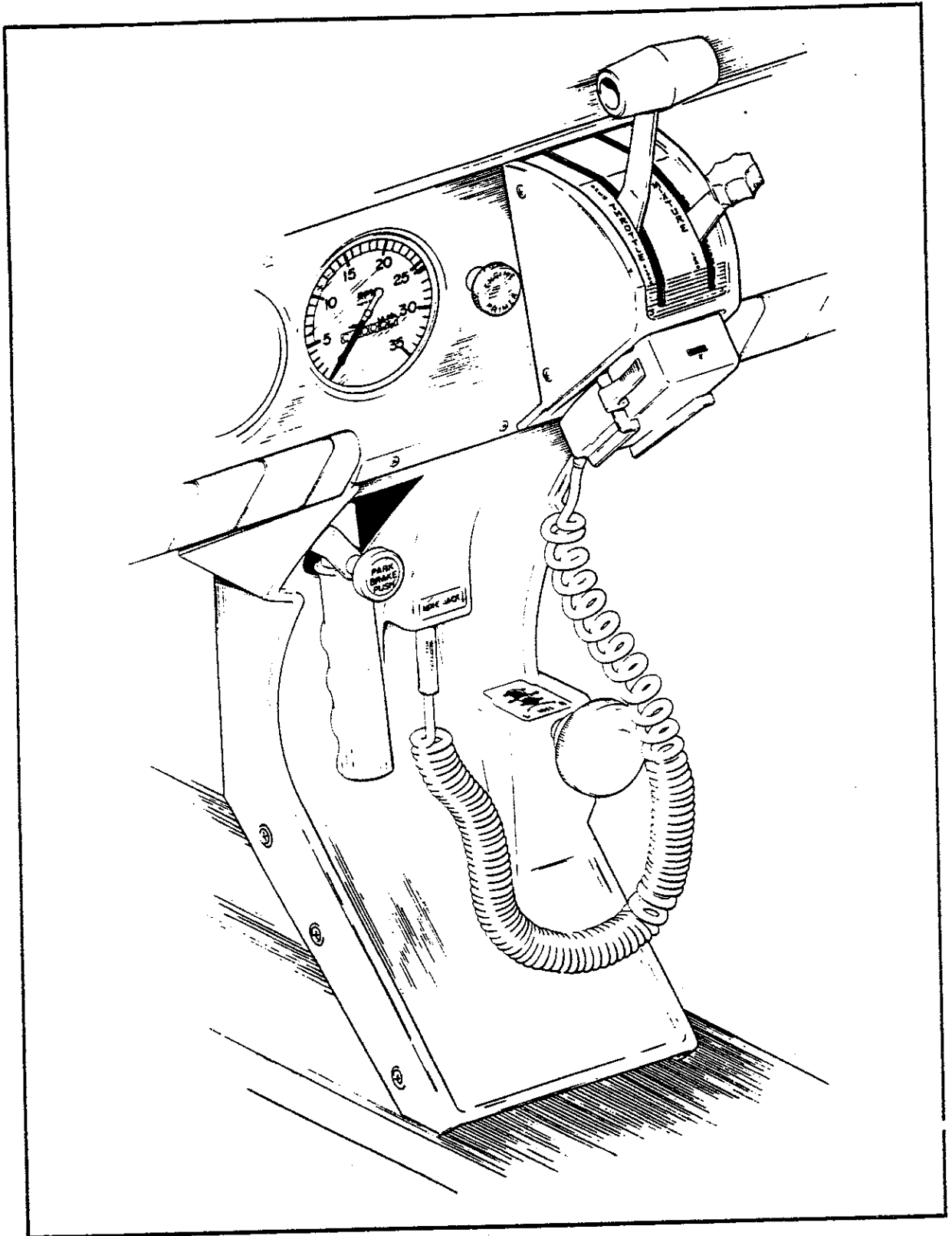

Throttle Quadrant and Console

CHEROKEE WARRIOR

LANDING GEAR

The fixed gear PA-28-151 is equipped with is a Cleveland 5.00 x 5 wheel on the nose gear and a Cleveland 6.00 x 6 wheel on each main gear. Cleveland single disc hydraulic brake assemblies are provided on the main gear. The nose gear has a 5.00 x 5 four ply tire, while the main wheel assemblies have 6.00 x 6 four ply tires. At gross weight, the main gear tires require a pressure of 24 psi, and the nose gear tire requires a pressure of 30 psi.

The nose gear is steerable through a 30 degree arc each side of center by the use of the rudder pedals and toe brakes. A spring device is incorporated for rudder centering and to provide rudder trim. A bungee assembly on the nose gear steering mechanism reduces ground steering effort and dampens shocks and bumps during taxiing. The steering mechanism also incorporates a shimmy dampener.

The three struts are of the air-oil type with the normal static load extension being 3.25 inches for the nose gear and 4.50 inches for the main gear.

The brakes are actuated by toe brake pedals which are attached to the rudder pedals or by a hand lever and master cylinder located below and behind the center of the instrument sub panel. Hydraulic cylinders are located above each pedal and adjacent to the hand brake lever. The brake fluid reservoir is installed on the top left front face of the fire wall. The parking brake is incorporated in the master cylinder and is actuated by pulling back on the brake lever and depressing the knob attached to the left side of the handle. To release the parking brake, pull back on the brake lever to disengage the catch mechanism and allow the handle to swing forward.

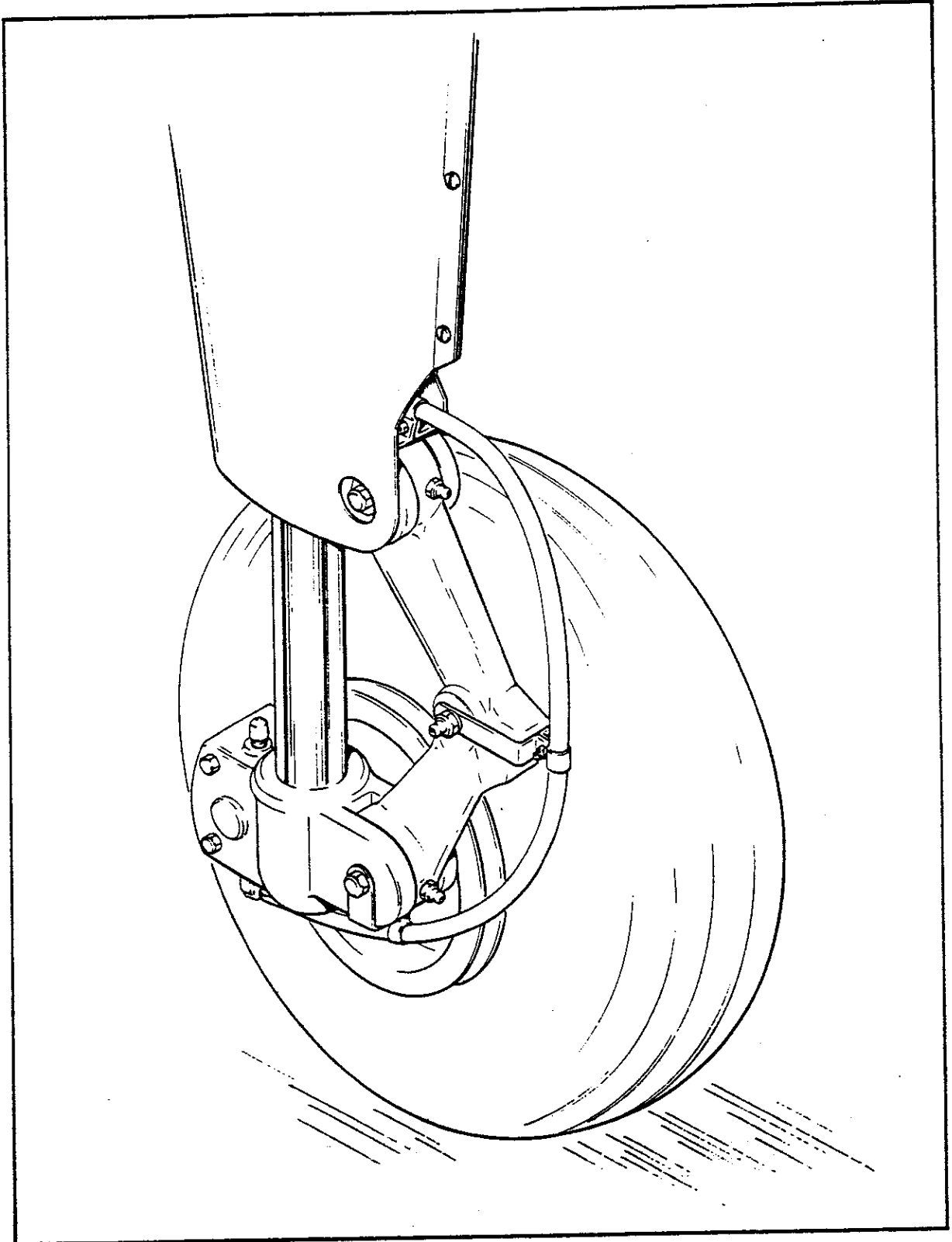

Main Wheel Assembly

CHEROKEE WARRIOR

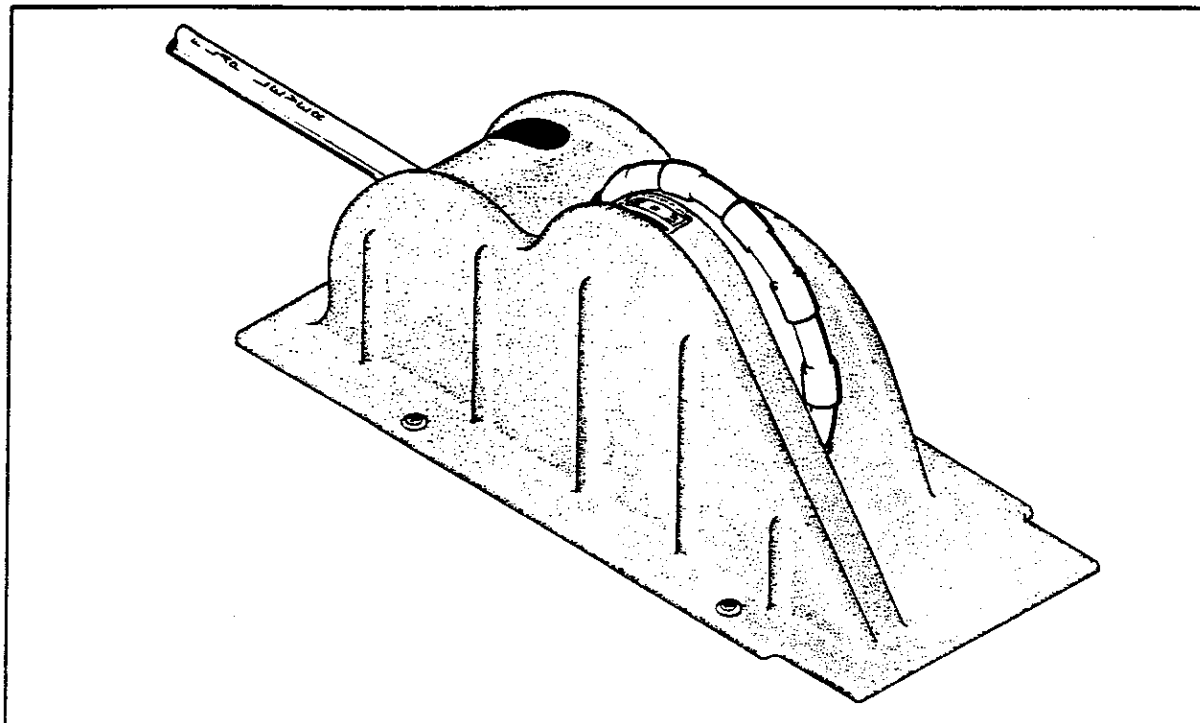

Console

FLIGHT CONTROLS

Dual flight controls are provided on the Warrior as standard equipment. The flight controls actuate the control surfaces through a cable system.

The horizontal surface (stabilator) is of the flying tail design with a trim tab mounted on the trailing edge. This tab serves the dual function of providing trim control and pitch control forces. The trim tab is actuated by a trim control wheel located on the control console between the front seats. Forward rotation of the wheel gives nose down trim and aft rotation gives nose up trim. The stabilator provides extra stability and controllability with less area, drag and weight than conventional tail surfaces.

The rudder is conventional in design and incorporates a rudder trim. The trim mechanism is a spring loaded recentering device. The trim control is located on the right side of the pedestal below the throttle quadrant. Turning the trim control clockwise gives nose right trim and counterclockwise rotation gives nose left trim.

Ailerons are provided with a differential deflection. This feature reduces adverse yaw in turning maneuvers, thus reducing the amount of coordination required. An aileron centering spring incorporated in the aileron control system on early models centers the aileron by returning the control wheel to neutral.

Manually controlled flaps are provided on the PA-28-151. The flaps are balanced for light operating forces and spring loaded to return to the retracted (up) position. A control handle, which is located between the two front seats on the control console, extends the flaps by the use of a control cable. To extend the flaps, the handle is pulled up to the desired flap setting of 10, 25 or 40 degrees. To retract, depress the button on the end of the handle and lower the control. When extending or retracting flaps, there is a pitch change in the airplane. This pitch change can be corrected either by stabilator trim or increased control wheel force. When the flaps are in the retracted (up) position the right flap, provided with an over-center lock mechanism, acts as a step.

NOTE

The right flap will support a load only in the fully retracted (up) position. When the flap is to be used as a step, make sure the flaps are in the retracted (up) position.

FUEL SYSTEM

Fuel is stored in two twenty-five gallon (24 gallons usable) fuel tanks, giving the airplane a total capacity of fifty U.S. gallons (48 gallons usable). The tanks are secured to the leading edge of each wing with screws and nut plates. This allows easy removal for service or inspection.

On serial numbers 7415001 through 7515449 each fuel tank has two outlets, one forward and one aft, to ensure an even fuel flow. Fuel is pumped from the tanks through the forward and aft tank outlets to fuel manifolds in the inboard section of either wing. Each manifold is a small collector with an inlet hose from each of the tank outlets, and an outlet hose to the fuel selector valve. On serial numbers 7615001 and up there is only one outlet on each tank and no fuel manifolds are used.

The fuel tank selector control is located on the left side panel forward of the pilot's seat. The button on the selector cover must be depressed and held while the handle is moved to the OFF position. The button releases automatically when the handle is moved back to the ON position.

An auxiliary electric fuel pump is provided in case of the failure of the engine driven pump. The electric pump should be ON for all takeoffs and landings and when switching tanks. The fuel pump switch is located in the switch panel above the throttle quadrant.

The fuel drains should be opened daily prior to first flight to check for water or sediment. Each tank has an individual drain at the bottom, inboard rear corner, and each fuel manifold (on early models only) is equipped with a drain. The outlets are located on the underside of the wings.

A gascolator, located on the lower left front of the fire wall, has a drain which is accessible from outside the nose section. The gascolator should also be drained before the first flight of the day. (See the Handling and Servicing Section for the complete fuel draining procedure.)

Fuel quantity and fuel pressure gauges are mounted in a gauge cluster located on the left side of the instrument panel to the right of the control wheel.

An optional engine priming system is available to facilitate starting. The primer pump is located to the immediate left of the throttle quadrant.

CHEROKEE WARRIOR

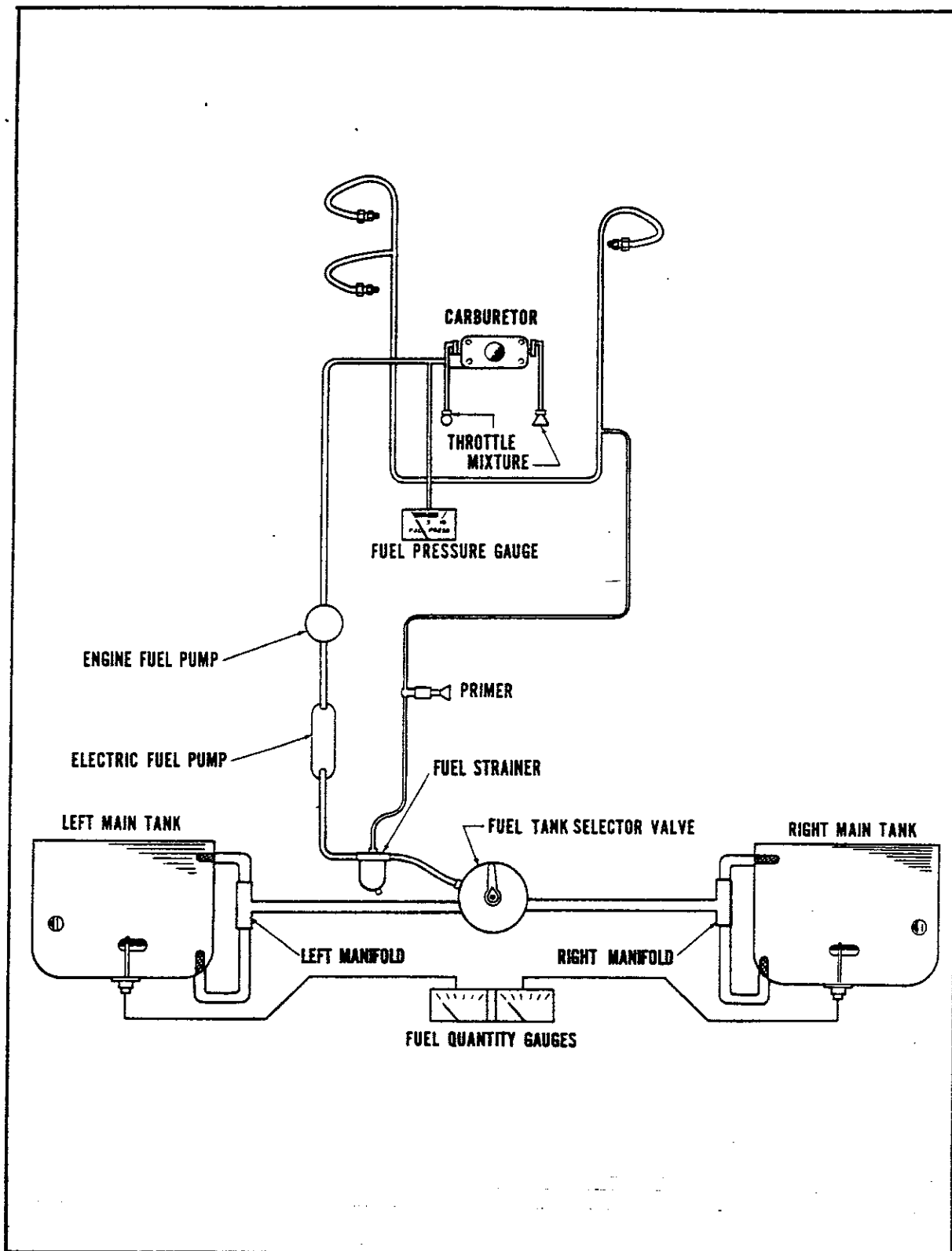

Fuel System Schematic (Ser. Nos. 7415001 through 7515449)

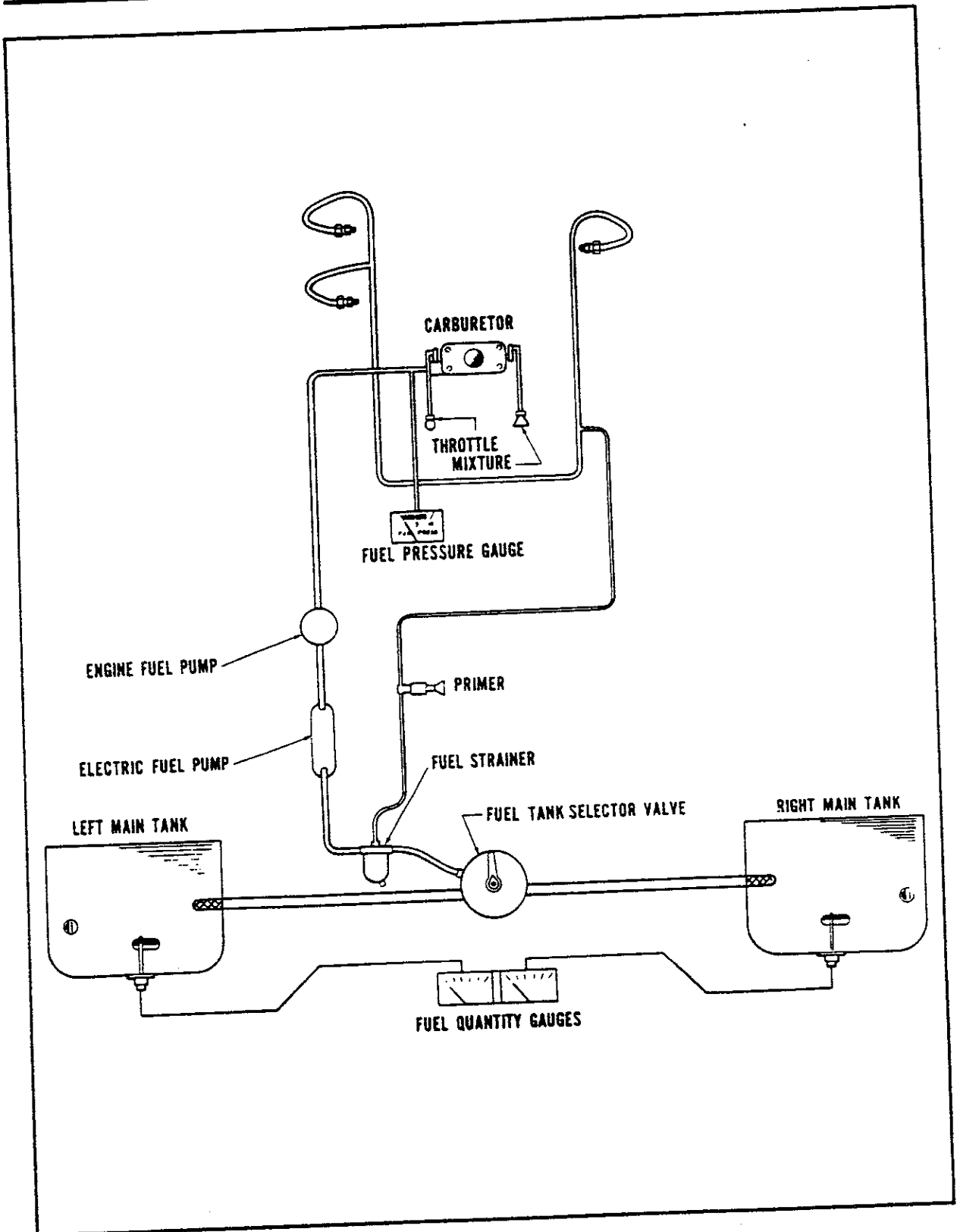

Fuel System Schematic (Ser. Nos. 7615001 and up)

THIS PAGE INTENTIONALLY LEFT BLANK

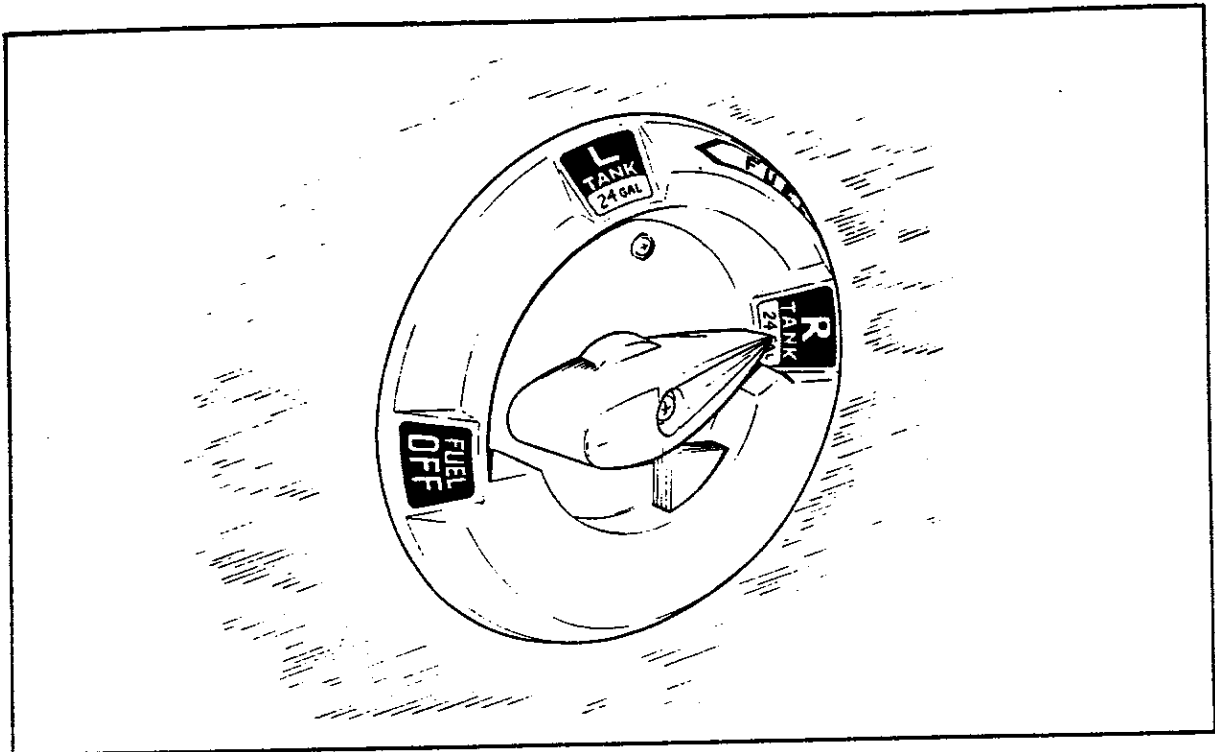

Fuel Selector

ELECTRICAL SYSTEM

The Cherokee Warrior is equipped with a simple but highly efficient electrical system that can be easily operated.

The electrical system includes a 14 volt 60 ampere alternator, voltage regulator, overvoltage relay, battery contactor and a standard 12 volt 25 ampere hour or an optional 12 volt 35 ampere hour battery. The battery is mounted in a thermoplastic box located immediately aft of the main spar on the right side of the fuselage below the rear passengers seat. The voltage regulator and overvoltage relay are located on the forward left side of the fuselage behind the instrument panel.

Electrical switches are located on the right center instrument panel, and the circuit breakers are located on the lower right instrument panel. A rheostat switch on the left side of the switch panel controls the optional navigation lights and the radio lights. A similar switch on the right side of the switch panel controls and dims the optional panel lights. The master switch, anti-collision light, landing light and fuel pump are also located on the switch panel and are controlled by rocker type switches.

WARNING

Strobe lights should not be operating when flying through overcast and clouds since reflected light can produce spacial disorientation. Do not operate strobe lights in close proximity to ground, during takeoff and landing.

CHEROKEE WARRIOR

A hinged door protects and gives easy access to the circuit breaker panel. Each circuit breaker on the panel is of the push to reset type and is clearly marked as to its function and amperage. Circuit provisions have been included to handle a full complement of communication and navigational equipment.

Standard electrical accessories include a starter, an electric fuel pump, an audible stall warning indicator, fuel gauges, ammeter, and annunciator panel*.

The annunciator panel* includes alternator and low oil pressure indicator lights. When the optional gyro system is installed, the annunciator panel also includes a low vacuum indicator light. The annunciator panel lights are provided only as a warning to the pilot that a system may not be operating properly, and that he should check and monitor the applicable system gauge to determine when or if any necessary action is required.

The system also provides for such optional electrical accessories as additional lights and gauges, a heated pitot head, and communication and navigational equipment.

The master switch is a split rocker switch. One side of the switch is the battery side ("BAT") and the other is the alternator side ("ALT"). Henceforth, the words "master switch" used in this manual will mean both "BAT" and "ALT" switches and they are to be depressed simultaneously to OFF or ON as directed.

Primary electrical power is provided by the 14 volt 60 amp alternator. The alternator system offers many advantages over the generator system both in operation and maintenance. The main advantage is full electrical power output at lower engine RPM. This provides improved radio and electrical equipment operation and increased battery life by reducing battery load. This will make cold weather starting easier.

Secondary electrical power is provided by the standard or optional battery.

Unlike previous generator systems, the ammeter as installed does not show battery discharge; rather, it indicates the electrical load on the alternator in amperes. With all the electrical equipment off and the master switch on, the ammeter will indicate the charging rate of the battery. As each electrical unit is switched on, the ammeter will indicate the total ampere draw of all the units including the battery. For example, the maximum continuous load for night flight with radios on is about 30 amperes. This 30 ampere value plus approximately 2 amperes for a fully charged battery will appear continuously under these flight conditions. The amount of current shown on the ammeter will tell immediately if the alternator system is operating normally, as the amount of current shown should equal the total amperage drawn by the electrical equipment which is operating.

If no output is indicated on the ammeter during flight, reduce the electrical load by turning off all unnecessary electrical equipment. Check both the 5 ampere field breaker and the 60 ampere output breaker and reset if open. If neither circuit breaker is open, turn the "ALT" switch off for 1 second to reset the overvoltage relay. If the ammeter continues to indicate no output, maintain minimum electrical load and terminate the flight as soon as practical.

Maintenance on the alternator should prove to be a minor factor. Should service be required, contact the local Piper Dealer.

*Serial nos. 7515001 and up

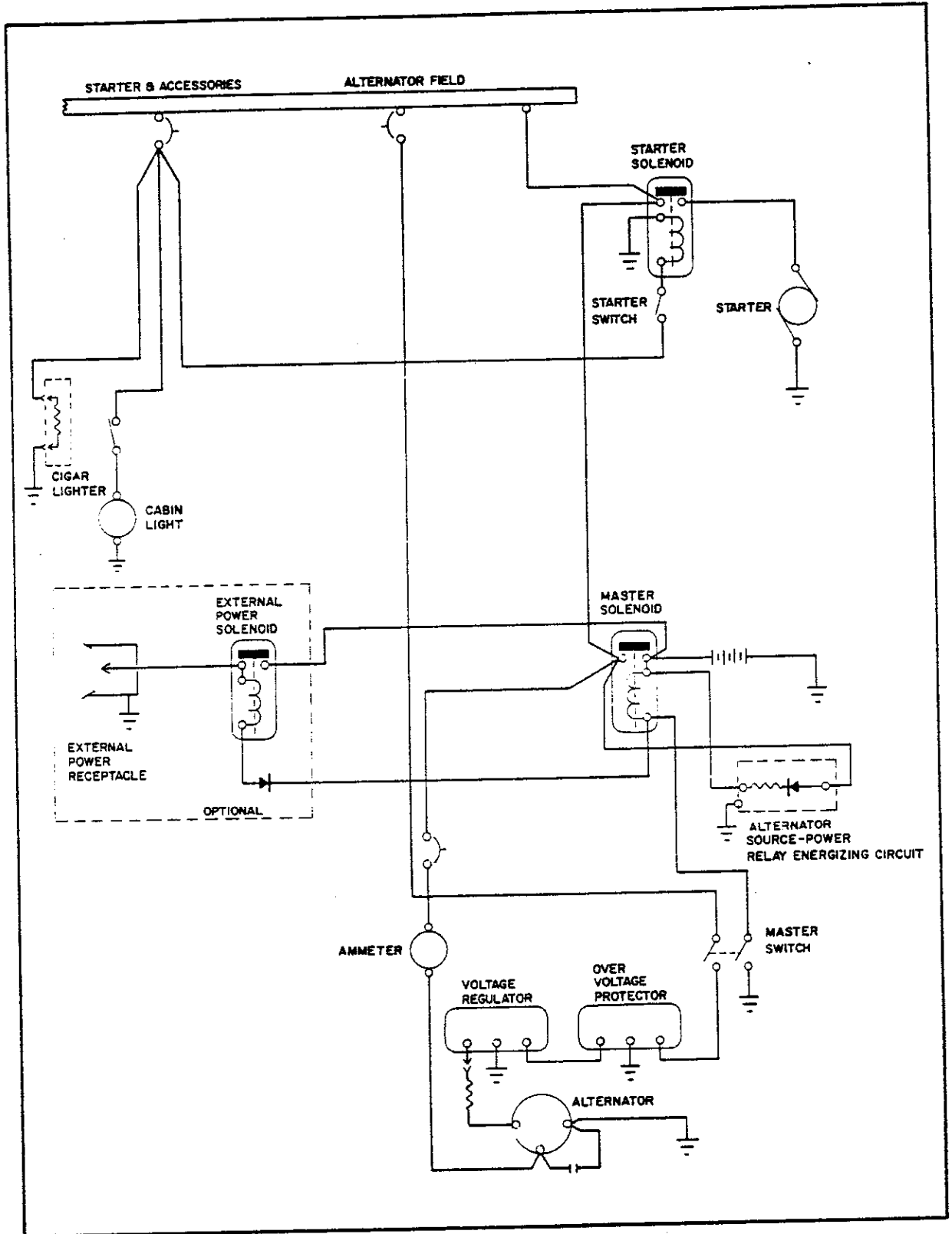

Alternator and Starter Schematic (Ser. Nos. 7415001 through 7415731)

CHEROKEE WARRIOR

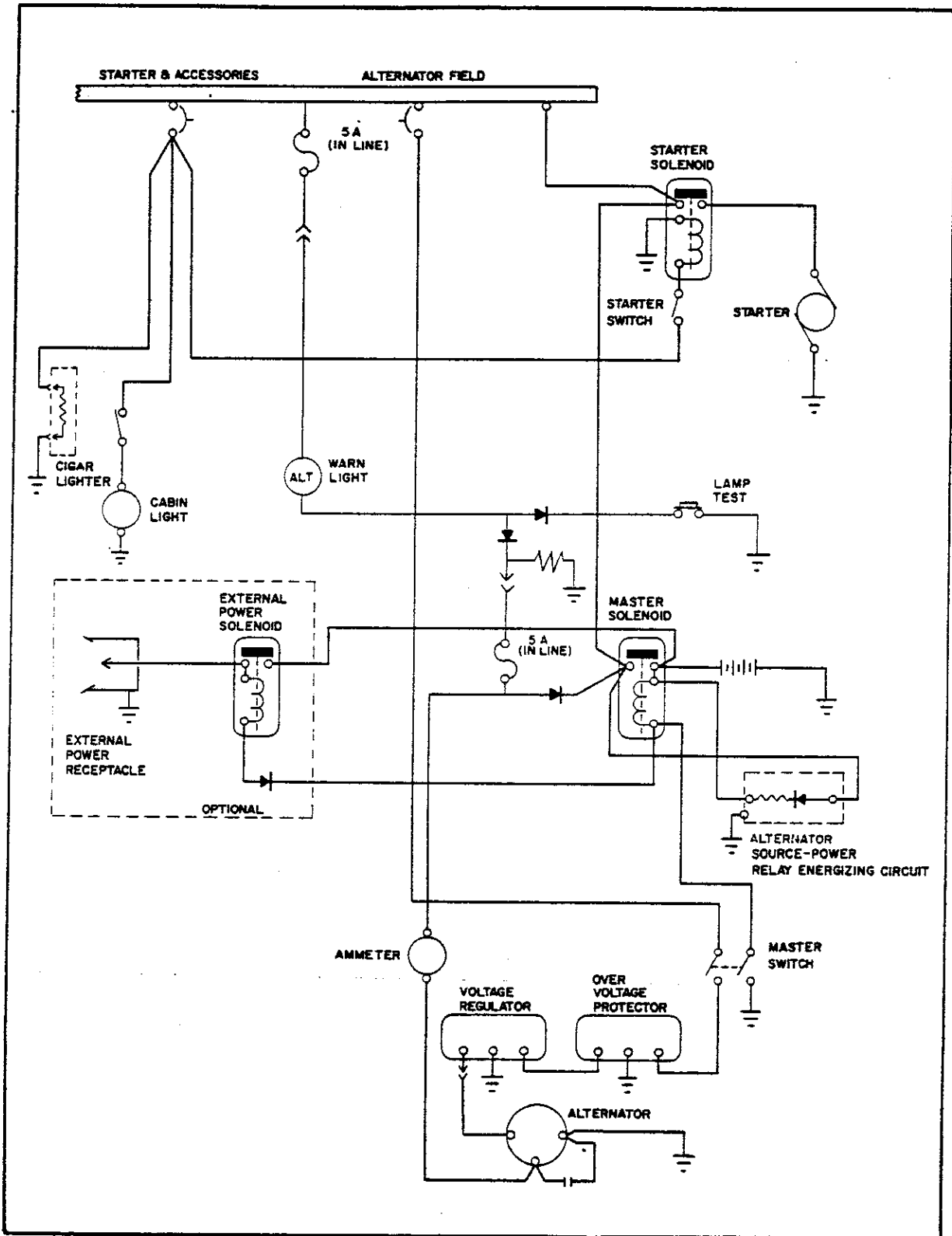

Alternator and Starter Schematic (Ser. Nos. 7515001 and up)

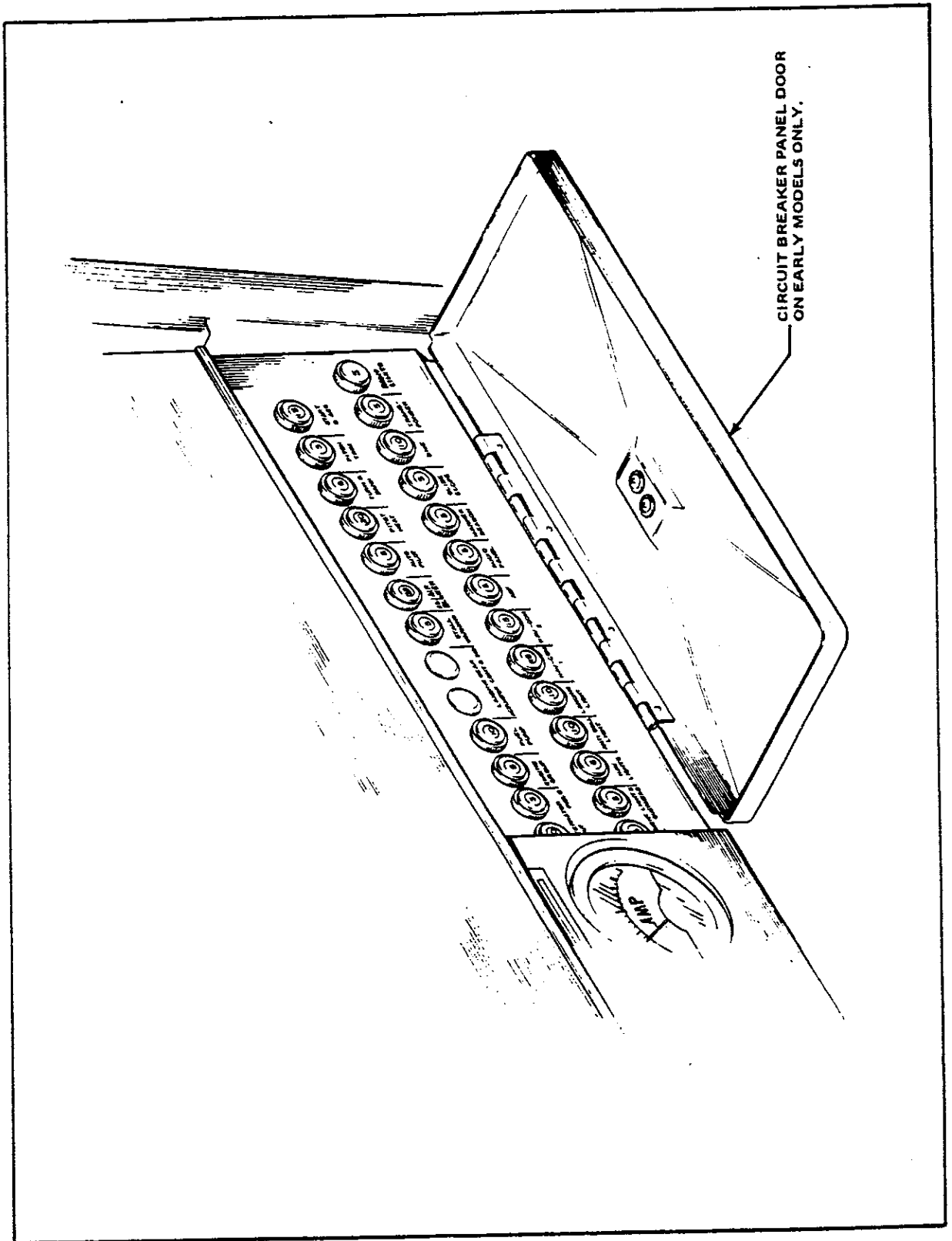

Circuit Breaker Panel

THIS PAGE INTENTIONALLY LEFT BLANK

VACUUM SYSTEM*

The vacuum system is designed to operate the air driven gyro instruments. This includes the directional and attitude gyros when installed. The system consists of an engine driven vacuum pump, a vacuum regulator, a filter and the necessary plumbing.

The vacuum pump is a dry type pump which eliminates the need for an air/oil separator and its plumbing. A shear drive protects the pump from damage. If the drive shears, the gyros will become inoperative.

A vacuum gauge, mounted on the far right instrument panel provides a pilot check for the system during operation. A decrease in pressure in a system that remained constant over an extended period may indicate a dirty filter, dirty screens, possibly a sticky vacuum regulator or leak in the system (a low vacuum indicator light is provided in the annunciator panel**). Zero pressure would indicate a sheared pump drive, defective pump, possibly a defective gauge or collapsed line. In the event of any gauge variation from the norm, the pilot should have a mechanic check the system to prevent possible damage to the system components or eventual failure of the system.

A vacuum regulator is provided in the system to protect the gyros. The valve is set so the normal vacuum reads $5.0 \pm .1$ inches of mercury, a setting which provides sufficient vacuum to operate all the gyros at their rated RPM. Higher settings will damage the gyros and with a low setting the gyros will be unreliable. The regulator is located behind the instrument panel.

INSTRUMENT PANEL

The instrument panel is designed to be functional and professional, accommodating complete instruments and avionics equipment for VFR and IFR flights. A wide range of optional instruments and avionics permit an equipment selection to suit individual needs.

A natural separation of the flight group and power group is provided by placing the flight group in the upper instrument panel and the power group in the center and lower instrument panels. The radios and the circuit breakers are located on the upper and lower right panel respectively, and have circuits provided for a complete line of optional radio equipment. An engine cluster is located to the right of the pilot control wheel and includes a fuel pressure gauge, a right and left main fuel quantity gauge, an oil temperature gauge and an oil pressure gauge.

Standard instruments on the Warrior panel include a compass, an airspeed indicator, a tachometer, an altimeter, an ammeter, an engine cluster, and an annunciator panel**. The compass is mounted to the top of the instrument panel in clear view of the pilot. The annunciator panel is mounted in the upper instrument panel to warn the pilot of a possible malfunction in the alternator, oil pressure, or vacuum systems.

A complete line of instrument options available for the panel includes a suction gauge, vertical speed indicator, attitude gyro, directional gyro, clock, true-speed indicator and a turn and slip indicator or turn coordinator. The attitude gyro and directional gyro are vacuum operated through the use of a vacuum pump installed on the engine, while the turn and slip indicator is electrically operated. The vacuum suction gauge is on the far right of the instrument panel.

*Optional equipment

**Serial nos. 7515001 and up

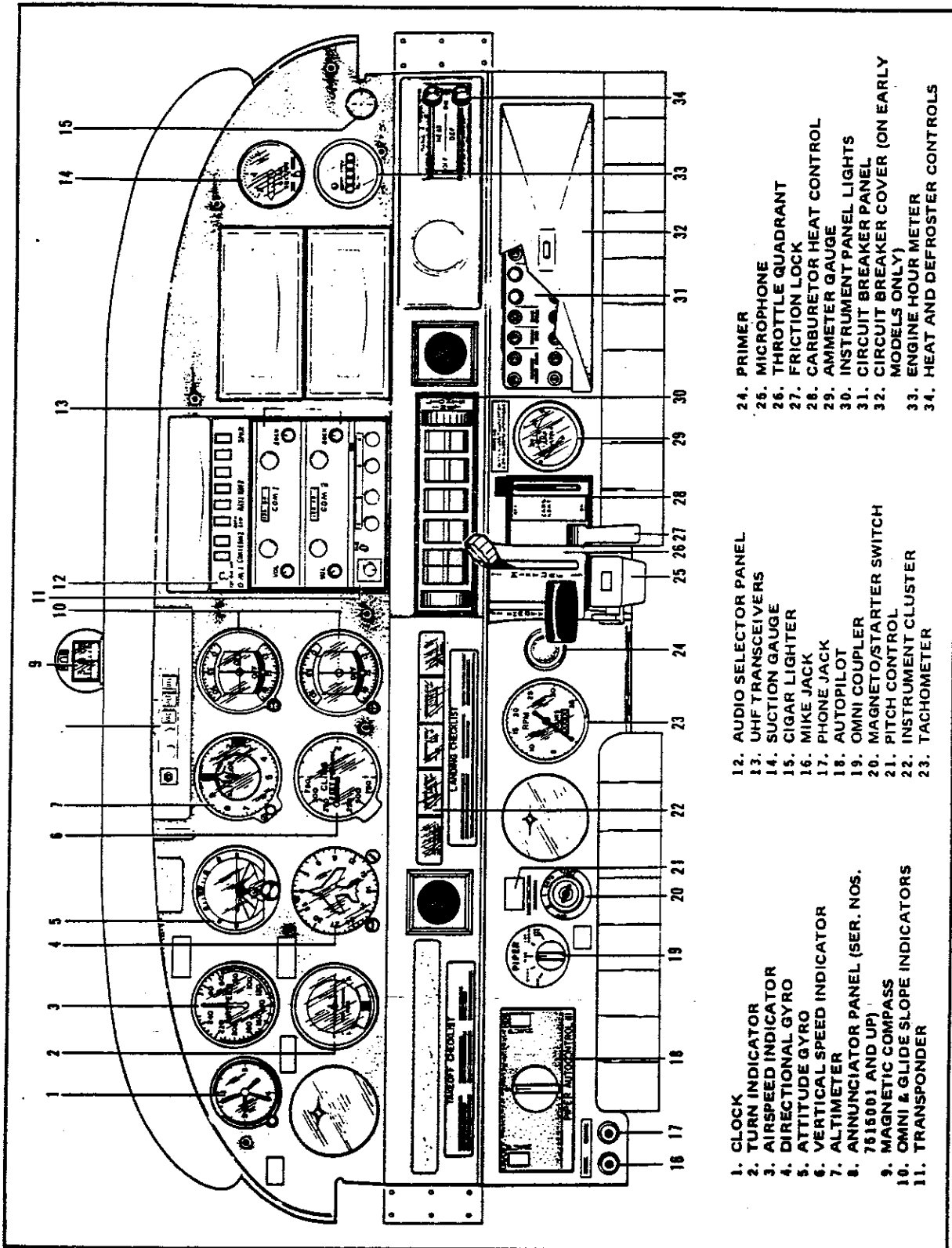

- 1. CLOCK
- 2. TURN INDICATOR
- 3. AIRSPEED INDICATOR
- 4. DIRECTIONAL GYRO
- 5. ATTITUDE GYRO
- 6. VERTICAL SPEED INDICATOR
- 7. ALTIMETER
- 8. ANNUNCIATOR PANEL (SER. NOS. 7515001 AND UP)
- 9. MAGNETIC COMPASS
- 10. OMNI & GLIDE SLOPE INDICATORS
- 11. TRANSPONDER
- 12. AUDIO SELECTOR PANEL
- 13. UHF TRANSCEIVERS
- 14. SUCTION GAUGE
- 15. CIGAR LIGHTER
- 16. MIKE JACK
- 17. PHONE JACK
- 18. AUTOPILOT
- 19. OMNI COUPLER
- 20. MAGNETO/STARTER SWITCH
- 21. PITCH CONTROL
- 22. INSTRUMENT CLUSTER
- 23. TACHOMETER
- 24. PRIMER
- 25. MICROPHONE
- 26. THROTTLE QUADRANT
- 27. FRICTION LOCK
- 28. CARBURETOR HEAT CONTROL
- 29. AMMETER GAUGE
- 30. INSTRUMENT PANEL LIGHTS
- 31. CIRCUIT BREAKER PANEL
- 32. CIRCUIT BREAKER COVER (ON EARLY MODELS ONLY)
- 33. ENGINE HOUR METER
- 34. HEAT AND DEFROSTER CONTROLS

Instrument Panel

PITOT-STATIC SYSTEM

The system supplies both pitot and static pressure for the airspeed indicator, altimeter, and the optional vertical speed indicator.

Pitot and static pressure are picked up by a pitot head installed on the bottom of the left wing and carried through pitot and static lines within the wing and fuselage to the gauges on the instrument panel.

A static valve, which is mounted to the knee guard below the instrument panel on the left side, provides an alternate static source for the system when opened.

Both the pitot and static lines can be drained through separate drain valves located on the left lower side of the fuselage interior.

A heated pitot head, which alleviates problems with icing and heavy rain, is available as optional equipment. The switch for the heated pitot head is located on the electrical switch panel to the left of the right control wheel.

To prevent bugs and water from entering the pitot and static pressure holes, a cover should be placed over the pitot head. A partially or completely blocked pitot head will give erratic or zero readings on the instruments.

NOTE

During the preflight, check to make sure the pitot cover is removed.

HEATING AND VENTILATING SYSTEM

Heat for the cabin interior and the defroster system is provided by a shroud attached to the muffler. The amount of heat can be regulated with the controls located on the far right side of the instrument panel.

The airflow between front and rear seats can be regulated by the heat diversion controls located on either side of the console atop the heat ducts.

CAUTION

When cabin heat is operated, heat duct surface becomes hot. This could result in burns if arms or legs are placed too close to heat duct outlets or surface.

Fresh air inlets are located in the leading edges of the wings on the fin. At each front seat location there is a large adjustable fresh air outlet on the side of the cabin near the floor. Rear seat vents are optional. Cabin air is exhausted through an outlet located below the rear seat.

An optional overhead ventilating system with outlets over each seat is also available. An additional option to aid in fresh air circulation is a cabin air blower to force air through the overhead vent system. This blower is operated by a fan switch with four positions - "OFF," "LOW," "MED," and "HIGH." The switch is located on the right side of the instrument panel with the heater and defroster controls.

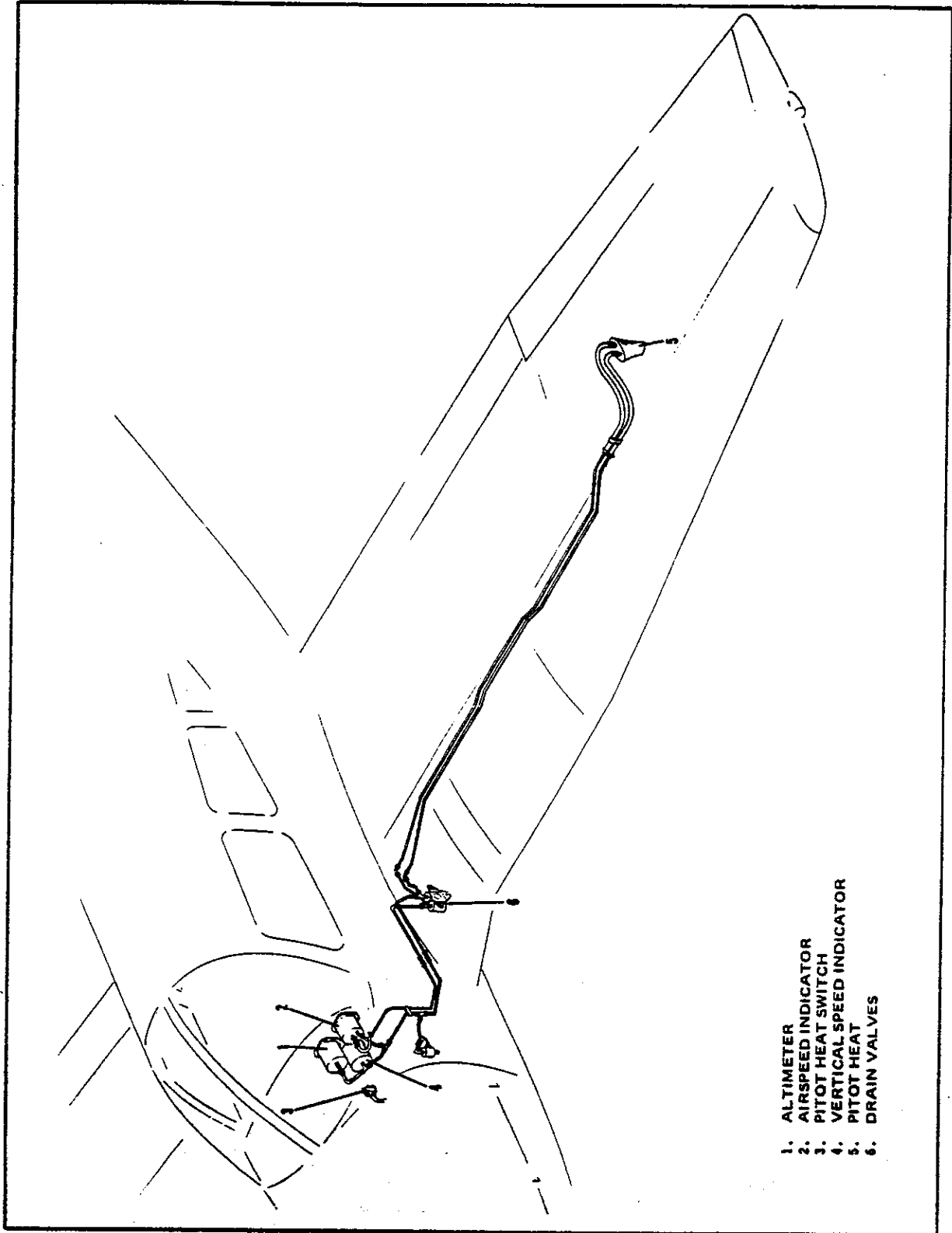

Pitot-Static System

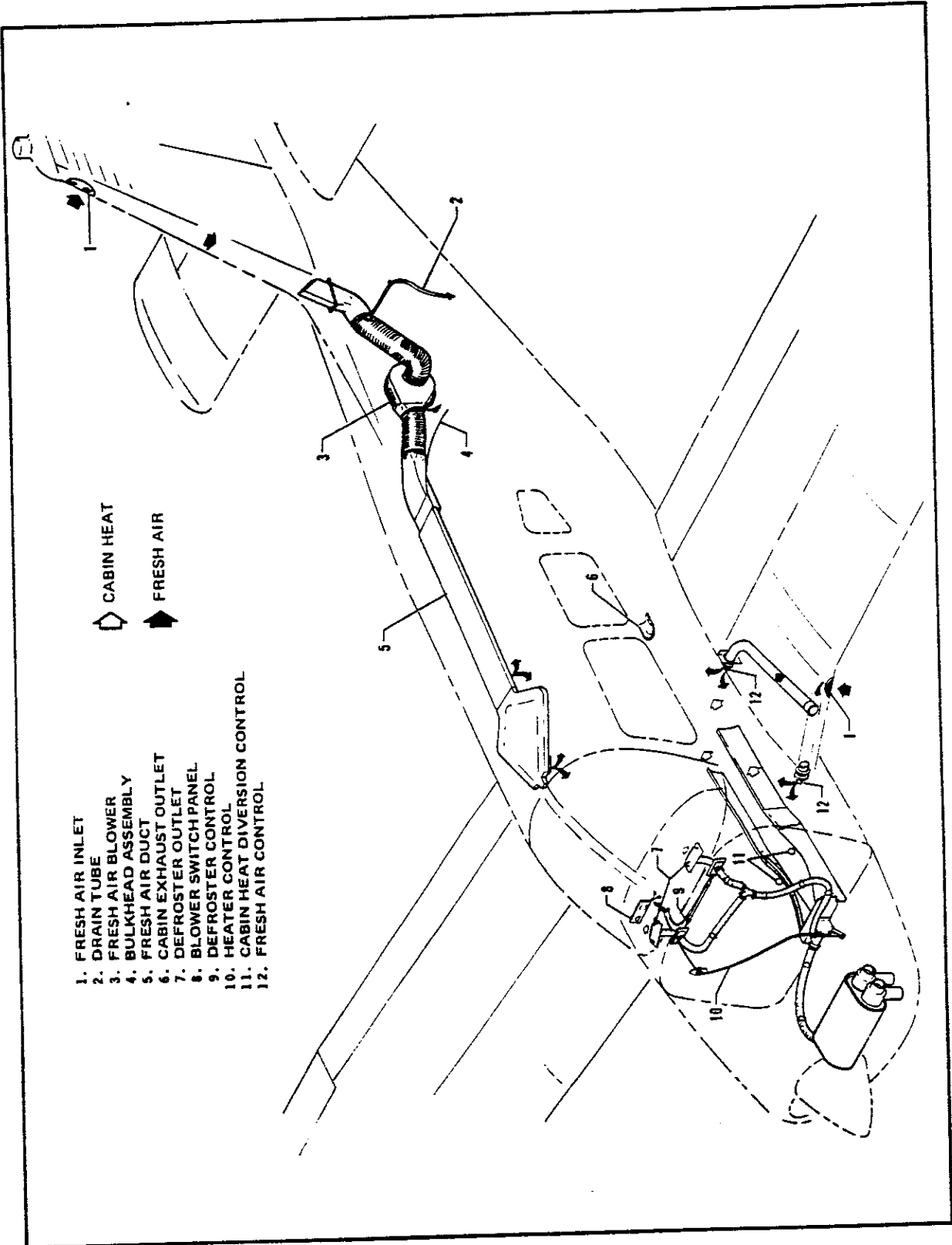

Heating and Ventilating System

CHEROKEE WARRIOR

CABIN FEATURES

For ease of entry and exit and for pilot-passenger comfort, the front seats are adjustable fore and aft. The right front seat tilts forward to allow easy entry to the rear seats. The cabin interior includes a pilot storm window, ash trays and armrests on each front seat, two map pockets and pockets on the backs of the front seats.

The front seats can be equipped with optional headrests and optional push button vertical adjustment.

Seat belts are standard equipment for both front and rear seats. The shoulder straps controlled by inertia reels are standard equipment on the front seats and are offered as an option for the rear seats. The shoulder strap is routed over the shoulder adjacent to the window and attached to the seat belt in the general area of the occupants' inboard hip.

A check of the inertia reel mechanism is made by pulling sharply on the strap. The reel should lock in place under this test and prevent the strap from extending. For normal body movements, the strap will extend or retract as required.

BAGGAGE AREA

A 24 cubic foot baggage area, located behind the rear seat, is accessible from the cabin or loaded through a large 20 x 22 inch outside baggage door on the right side of the fuselage. Maximum capacity is 200 pounds. Tie-down straps are available and they should be used at all times.

NOTE

It is the pilot's responsibility to be sure when the baggage is loaded that the aircraft C.G. falls within the allowable C.G. range. (See Weight and Balance Section.)

STALL WARNING

An approaching stall is indicated by an audible alarm located behind the instrument panel. The indicator activates at between five and ten miles per hour above stall speed.

FINISH

All exterior surfaces are primed with etching primer and finished with a durable acrylic lacquer which is available in a variety of colors and combinations. To keep the finish attractive, economy size spray cans of touch-up paint are available from Piper Dealers.

PIPER EXTERNAL POWER*

An optional starting installation known as Piper External Power (PEP) is accessible through a receptacle located on the right side of the fuselage aft of the baggage door. An external battery can be connected to the socket, thus allowing the operator to crank the engine without having to gain access to the airplane's battery. Instructions on a placard located on the cover of the receptacle should be followed before using the external power. For instructions on the use of the PEP see; **STARTING WITH EXTERNAL POWER** under the Operating Instructions Section of this manual.

*Optional equipment

1950-1951
1952-1953
1954-1955
1956-1957
1958-1959
1960-1961
1962-1963
1964-1965
1966-1967
1968-1969
1970-1971
1972-1973
1974-1975
1976-1977
1978-1979
1980-1981
1982-1983
1984-1985
1986-1987
1988-1989
1990-1991
1992-1993
1994-1995
1996-1997
1998-1999
2000-2001
2002-2003
2004-2005
2006-2007
2008-2009
2010-2011
2012-2013
2014-2015
2016-2017
2018-2019
2020-2021
2022-2023
2024-2025

AIRPLANE FLIGHT MANUAL

Log of Revisions	3-iii
Limitations	3-1
Procedures	3-5
Performance	3-7
Supplements	3-9

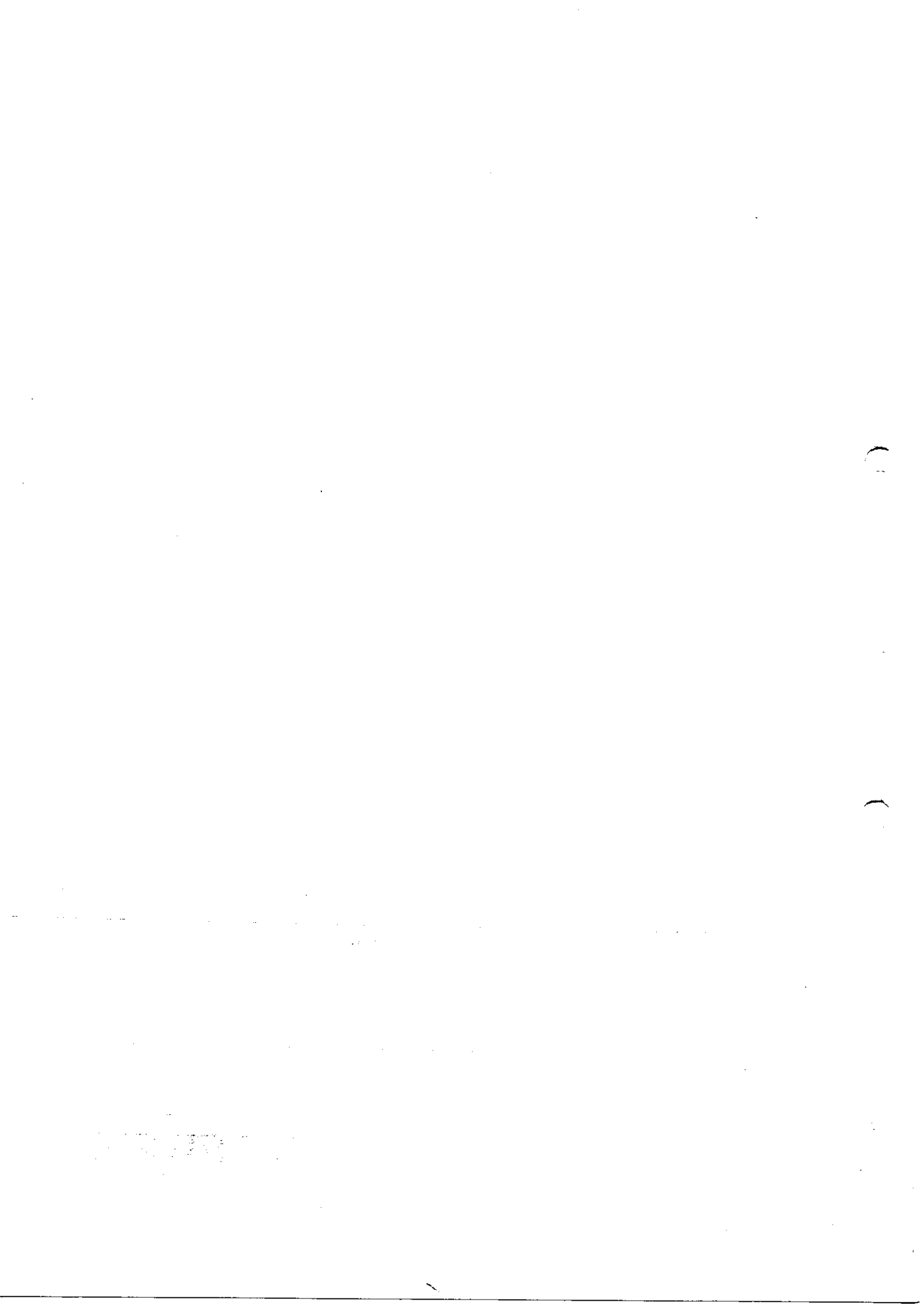

AIRPLANE FLIGHT MANUAL

FOR

CHEROKEE WARRIOR

APPLICABLE TO AIRCRAFT SERIAL NUMBERS 28-7415001 THROUGH 28-7615435

WARNING

EXTREME CARE MUST BE EXERCISED TO LIMIT THE USE OF THIS MANUAL TO APPLICABLE AIRCRAFT. THIS MANUAL REVISED AS INDICATED BELOW OR SUBSEQUENTLY REVISED IS VALID FOR USE WITH THE AIRPLANE IDENTIFIED BELOW WHEN APPROVED BY PIPER AIRCRAFT CORPORATION. SUBSEQUENT REVISIONS SUPPLIED BY PIPER AIRCRAFT CORPORATION MUST BE PROPERLY INSERTED.

MODEL PA-28-151

AIRCRAFT SERIAL NO. 28-7415449 REGISTRATION NO. _____

AIRPLANE FLIGHT MANUAL, REPORT NUMBER VB-573 REVISION 11

PIPER AIRCRAFT CORPORATION
APPROVAL SIGNATURE AND STAMP *Anne M. Boyer*
Anne M. Boyer

NOTE

THIS MANUAL MUST BE KEPT IN THE AIRPLANE AT ALL TIMES

FAA APPROVED BY:

H. W. Barnhouse
H. W. BARNHOUSE
PIPER AIRCRAFT CORPORATION
D. O. A. NO. SO-1
VERO BEACH, FLORIDA

DATE OF APPROVAL: JULY 25, 1973

APPROVAL BASIS: CAR 3 AND FAR PART 21, SUBPART J.

REPORT: VB-573
MODEL: PA-28-151

1. The first part of the document discusses the importance of maintaining accurate records of all transactions and activities. It emphasizes the need for transparency and accountability in financial reporting.

2. The second part of the document outlines the various methods and techniques used to collect and analyze data. It includes a detailed description of the experimental procedures and the statistical analysis performed.

3. The third part of the document presents the results of the study, including a comparison of the different methods and techniques used. It discusses the strengths and weaknesses of each method and provides a summary of the findings.

4. The fourth part of the document discusses the implications of the study and provides recommendations for future research. It highlights the need for further investigation into the effectiveness of the different methods and techniques used.

TABLE OF CONTENTS

Log of Revisions 3-iii

SECTION I

 Limitations 3-1

 A. Engine 3-1

 B. Fuel 3-1

 C. Propeller 3-1

 D. Power Instruments 3-1

 E. Airspeed Limitations and Airspeed Instrument Markings
 (Calibrated Airspeed) (MPH) 3-2

 F. Maximum Weight 3-2

 G. Baggage Capacity 3-2

 H. C. G. Range 3-2

 I. Maneuvers 3-3

 J. Placards 3-3

SECTION II

 Procedures 3-5

SECTION III

 Performance 3-7

SECTION IV

 Optional Equipment 3-9

 A. Electric Pitch Trim Installation 3-11

 B. AutoFlite II Installation 3-15

 C. Installation of Piper AutoControl III and/or AutoControl IIIB 3-17

THIS PAGE INTENTIONALLY LEFT BLANK

- b. Obtain measurement "A" by measuring from a plumb bob dropped from one wing leading edge, at the intersection of the straight and inboard tapered section, horizontally and parallel to the airplane centerline, to the main wheel centerline.
- c. Obtain measurement "B" by measuring the distance from the main wheel centerline, horizontally and parallel to the airplane centerline, to each side of the nose wheel axle. Then average the measurements.
- d. The empty weight center of gravity (as weighed including optional equipment and undrainable oil) can be determined by the following formula:

$$C.G. \text{ Arm} = 78.4 + A - \frac{B(N)}{T}$$

$$C. G. \text{ Arm} = 78.4 + (\quad) - \frac{(\quad)(\quad)}{(\quad)} = \quad \text{inches}$$

5. LICENSED EMPTY WEIGHT AND EMPTY WEIGHT CENTER OF GRAVITY

	Weight	Arm	Moment
Empty Weight (as weighed)			
Unusable Fuel (2.0 gal.)	12 lb	103.0	1236
Licensed Empty Weight			

THIS PAGE INTENTIONALLY LEFT BLANK

Auftrags-Nr.: 1155/21

Muster: Piper PA-28-151

Werk-Nr.: 28-7415449

Kennzeichen: OE-DHU

Daten nach Kennblatt bzw. Flughandbuch

Grund der Wägung: Anbau Gomolzig Nachschalldämpfer

Bezugspunkt BP BE
 Bezugsebene BE 199cm vor der Flügelvorderkante
 Bezugslinie horiz. BL 2 Schrauben auf der linken Rumpffseite unter dem Fenster waagrecht

Lufttüchtig.-Gruppe Einheiten	Höchstmasse kg	Schwerpunktslage bei Flugmasse		bei Flugmasse kg
		X vorn cm	X hinten cm	
Normalflugzeug (N)	1055,000	221,000	236,000	885
		211,000	236,000	
Nutzflugzeug (U)	885,000	211,000	220,000	885

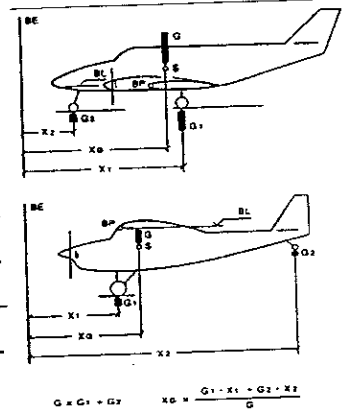

Ausrüstungsliste Stand vom _____

Plan der Fluggastraumgestaltung vom _____

Wägung und Schwerpunktslage bei Leermasse

Wägung	Auflage	Brutto-Masse		Tara-Masse	Netto-Masse	Hebelarm	Moment
		Einheiten	kg	kg	kg	cm	kgcm
links	G1 l	-	-	-	250,000	X1 276,600	69150,000
	G1 r	-	-	-	244,000		67490,400
rechts	G2	-	-	-	195,000	X2 71,300	13903,500
vom/hinten							
Summe A					689,000		150543,900

Abzüge	Ausfliegbarer Kraftstoff		Einheit				
	Dichte	kg / l					
	0,720					0,000	
Rumpfbehälter 1						0,000	
Rumpfbehälter 2						0,000	
Flügelbehälter 1	Nicht ausfliegb					0,000	
Flügelbehälter 2	Nicht ausfliegb					0,000	
Flügelbehälter 3						0,000	
Flügelbehälter 4						0,000	
						0,000	
						0,000	
						0,000	
						0,000	
						0,000	
Summe B					0,000	0,000	
Wägung (Summe A)					689,000	150543,900	
Abzüge (Summe B)					0,000	0,000	
Leermasse					689,000	218,496	150543,900

In der Leermasse sind enthalten:
 Schmierstoffe, Hydraulik- und Enteisungsflüssigkeit bei jeweils maximal zulässiger Füllung.

Straubing / EDMS 06.07.2021
 Ort Datum

Veränderliche Lasten

				Masse	Hebelarm	Moment
				kg	cm	kgcm
Kraftstoff	Dichte	0,720	kg / l			
Rumpfbehälter 1			l			
Rumpfbehälter 2			l			
Flügelbehälter 1			l			
Flügelbehälter 2			l			
Flügelbehälter 3			l			
Flügelbehälter 4			l			
Sitzplätze: Flugzeugführer			X kg			
			kg			
			kg			
			kg			
			kg			
Gepäck			kg			
Einsatzrüstung			kg			

Schwerpunktlage bei Flugmasse

(mögliche vordere und hintere Lage Xv und Xh)
 Massen und Hebelarme sind dem Flughandbuch zu entnehmen.

Beladung	Leermasse	689,000	218,496	150543,900
Rumpfbehälter 1				
Rumpfbehälter 2				
Flügelbehälter 1				
Flügelbehälter 2				
Flügelbehälter 3				
Flügelbehälter 4				
Sitzplätze: Flugzeugführer				
Gepäck				
Einsatzrüstung				
Gewichtstrimmung Einbauort		689,000	218,496	150543,900

Höchstzulässige Zuladung

Lufttüchtigk.-Gruppe

Höchstmasse

- Leermasse

höchstzul. Zuladung **kg**
 Einheit

	Normalflugzeug (N)	Nutzflugzeug (U)
Höchstmasse	1055,000	885,000
- Leermasse	689,000	689,000
höchstzul. Zuladung	366,000	196,000

Daten für den Eintrag ins Flughandbuch

Leermasse	Leermasse-Moment
689,000 kg	150543,900 kgcm
Einheit	Einheit

Zusätzliche Angaben für Flughandbuch und Hinweisschilder:
 Zwischen den Werten lineare Veränderungen

Straubing / EDMS

06.07.2021

M. Gühmann

Ort

Datum

Ausführender



[Handwritten Signature]
 Unterschrift Freigabeberechtigter / CS

AIRPLANE FLIGHT MANUAL LOG OF REVISIONS

Revision	Revised Pages	Description and Revision	FAA Approved Date
1	All 3-5	Completely revised to printed format for assembly into Pilot's Operating Manual 761 563. Revised spin recovery technique, item 3. c.	<i>H. W. Barnhouse</i> H. W. Barnhouse August 1, 1973
2	3-i 3-1 3-2 3-7 3-9 3-13 3-14 3-15 3-16	Revised Table of Contents Revised Item C. Propeller Limitations Revised Airspeed Range Revised Stall Speed Chart Revised List of Supplements Added page and Supplement B Added page Added page and Supplement C Added page	<i>H. W. Barnhouse</i> H. W. Barnhouse August 30, 1973
3	Title	Added PAC Approval Form. (NOTE: AIRCRAFT DELIVERED WITH MANUALS PRIOR TO THIS REVISION DO NOT REQUIRE THIS REVISION.)	<i>D. H. Trompler</i> D. H. Trompler May 31, 1974
4	3-i 3-9 3-17, 3-18, 3-19, 3-20	Added Item D. Installation of Piper AutoControl IIIB to supplements. Added Item D. Installation of Piper AutoControl IIIB. Added pages (AutoControl IIIB info).	<i>D. H. Trompler</i> D. H. Trompler June 14 1974
5	3-i 3-9	Changed Section IV title from Supplements to Optional Equipment; under Section IV - revised item A.; deleted item B.; revised remaining item nos.; added AutoControl III to new item C. Changed Section IV title from Supplements to Optional Equipment; revised NOTE; revised item A.; deleted item B.; revised remaining item letters; added AutoControl III to new item C.	

FAA APPROVED JULY 25, 1973
REVISED: JANUARY 17, 1975

REPORT: VB-573 PAGE 3-iii
MODEL: PA-28-151

AIRPLANE FLIGHT MANUAL LOG OF REVISIONS (cont)

Revision	Revised Pages	Description and Revision	FAA Approved Date
5 (cont)	3-11	Deleted (With Pitch Trim Switch) from item A. Electric Pitch Trim Installation.	<i>Ward Evans</i> Ward Evans Jan. 17, 1975
	3-13	Deleted item B. AutoControl III Installation.	
	3-15	Changed item C. to B.; added new items 2. b. (1) and (2); revised remaining item nos.; deleted item 3 - Performance.	
	3-17	Changed item D. to C.; added AutoControl III to title.	
	3-20	Deleted IIIB designation from items c. (1) and (2).	
6	3-2	Added ser. no. effectivity to Flaps Extended speed; added new Flaps Extended speed; added ser. no. effectivity to White Arc instrument marking; added new White Arc instrument marking.	<i>Ward Evans</i> Ward Evans July 14, 1975
	3-3	Added ser. no. effectivity to Landing Check List; added new Landing Check List.	
	3-5	Revised item 3. (Spin procedure).	
7	3-20	Revised item c. (1).	<i>Ward Evans</i> Ward Evans Dec. 1, 1975
8	3-1	Revised item B. Fuel.	<i>Ward Evans</i> Ward Evans April 16, 1976
9	3-15	Revised Supplement B. AutoFlite II Installation.	<i>Ward Evans</i> Ward Evans June 3, 1977
10	Title	Added Applicable Serial Numbers. (NOTE: AIRCRAFT DELIVERED WITH MANUALS PRIOR TO THIS REVISION DO NOT REQUIRE THIS REVISION.)	<i>Ward Evans</i> Ward Evans Oct. 21, 1977

AIRPLANE FLIGHT MANUAL LOG OF REVISIONS (cont)

Revision	Revised Pages	Description of Revision	Approved Date
11	3-20	Revised item c.(1)	<p><i>D.H. Trompler</i> D.H. Trompler November 10, 1988</p>

FAA APPROVED: JULY 25, 1973
 REVISED: NOVEMBER 7, 1988

REPORT: VB-573 PAGE 3-v
 MODEL: PA-28-151

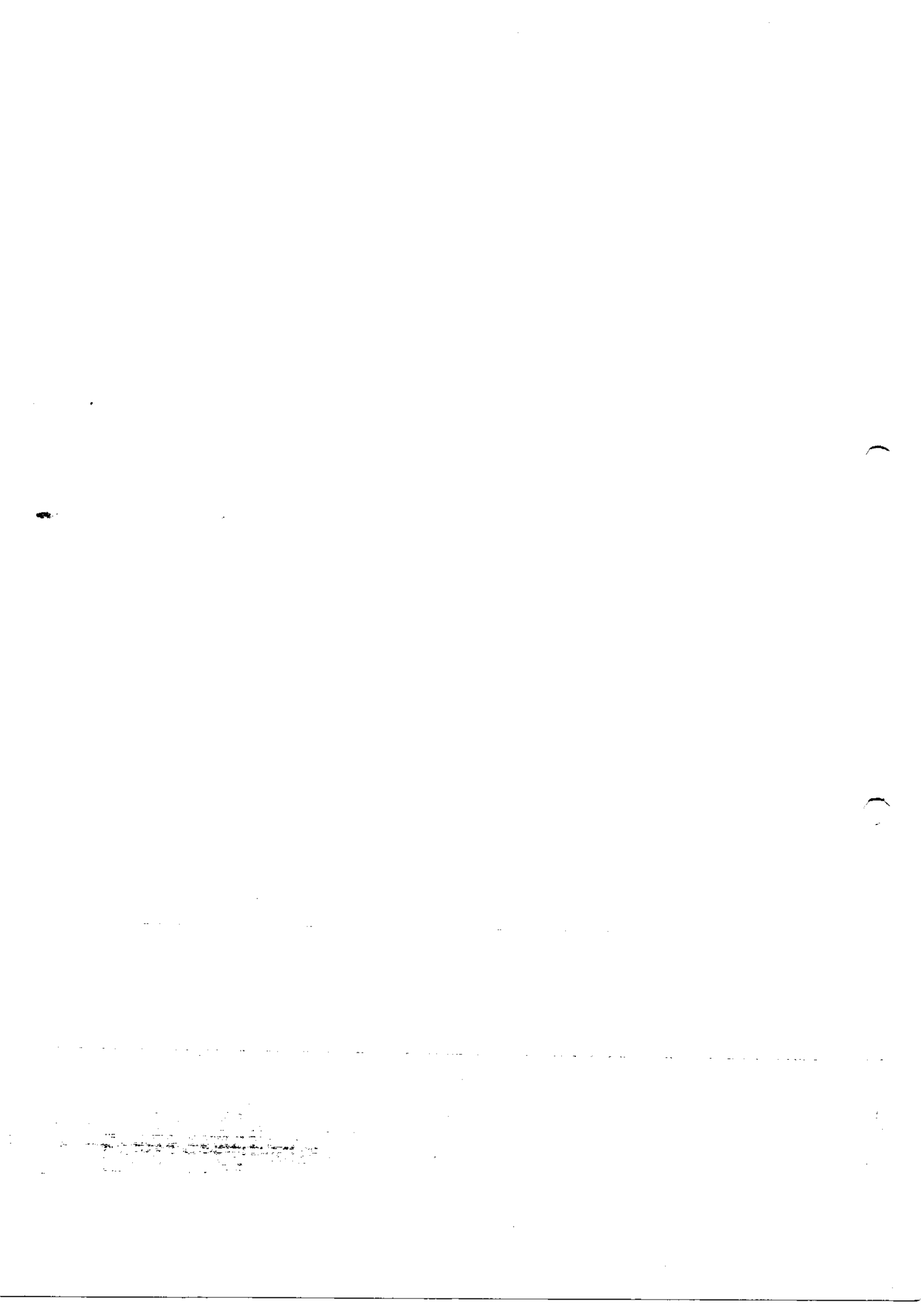

SECTION I
LIMITATIONS

The following limitations must be observed in the operation of this airplane:

- A. ENGINE
Lycoming O-320-E3D

ENGINE LIMITS
For all operations 2700 RPM, 150 HP

- B. FUEL
80/87 octane aviation fuel minimum grade

- C. PROPELLER
Sensenich 74DM6, maximum diameter 74 inches. Minimum diameter 72 inches. Static RPM at maximum permissible throttle setting: Not over 2375, not under 2275. No additional tolerance permitted.

McCauley 1C160/EGM7653, maximum diameter 76 inches. Minimum diameter 74.5 inches. Static RPM at maximum permissible throttle setting: Not over 2400, not under 2300. No additional tolerance permitted.

- D. POWER INSTRUMENTS

OIL TEMPERATURE	75° F to 245° F
Green Arc (Normal Operating Range)	245° F
Red Line (Maximum)	

OIL PRESSURE	60 PSI to 90 PSI
Green Arc (Normal Operating Range)	25 PSI to 60 PSI
Yellow Arc (Caution Range)	25 PSI
Red Line (Minimum)	90 PSI
Red Line (Maximum)	

FUEL PRESSURE	.5 PSI to 8 PSI
Green Arc (Normal Operating Range)	.5 PSI
Red Line (Minimum)	8 PSI
Red Line (Maximum)	

TACHOMETER	500 to 2700 RPM
Green Arc (Normal Operating Range)	2700 RPM
Red Line (Maximum Continuous Power)	

CHEROKEE WARRIOR

E. AIRSPEED LIMITATIONS AND AIRSPEED INSTRUMENT MARKINGS (Calibrated Airspeed)

NEVER EXCEED	176 MPH
MAXIMUM STRUCTURAL CRUISE	140 MPH
MANEUVERING	124 MPH
FLAPS EXTENDED (Ser. nos. 7415001 through 7515449)	125 MPH
FLAPS EXTENDED (Ser. nos. 7615001 and up)	115 MPH
MAXIMUM POSITIVE LOAD FACTOR	(Normal Category) 3.8
MAXIMUM POSITIVE LOAD FACTOR	(Utility Category) 4.4
MAXIMUM NEGATIVE LOAD FACTOR	No inverted maneuvers approved

AIRSPEED INSTRUMENT MARKINGS

Red Radial Line (Never Exceed)	176 MPH (153 KTS)
Yellow Arc (Caution Range) (Smooth Air Only)	140 MPH to 176 MPH (122 KTS to 153 KTS)
Green Arc (Normal Operating Range)	64.5 MPH to 140 MPH (56 KTS to 122 KTS)
White Arc (Flap Down Range) (Ser. nos. 7415001 through 7515449)	58 MPH to 125 MPH (50 KTS to 109 KTS)
White Arc (Flap Down Range) (Ser. nos. 7615001 and up)	58 MPH to 115 MPH (50 KTS to 100 KTS)

F. MAXIMUM WEIGHT

Normal Category	2325 LBS
Utility Category	1950 LBS

G. BAGGAGE CAPACITY

200 LBS

H. C. G. RANGE

The datum used is 78.4 inches ahead of wing leading edge at the intersection of the straight and tapered section.

1. Normal Category

Weight (Pounds)	Forward Limit (In. Aft of Datum)	Rearward Limit (In. Aft of Datum)
2325	87.0	93.0
1950	83.0	93.0

2. Utility Category

Weight (Pounds)	Forward Limit (In. Aft of Datum)	Rearward Limit (In. Aft of Datum)
1950	83.0	86.5

Straight line variation between points given.

NOTE

It is the responsibility of the airplane owner and the pilot to insure that the airplane is properly loaded. See Weight and Balance Section for proper loading instructions.

I. MANEUVERS

1. Normal Category - All acrobatic maneuvers including spins prohibited.
2. Utility Category - Approved maneuvers for Utility Category only.

	Entry Speed
Steep Turns	124 MPH
Lazy Eights	124 MPH
Chandelles	124 MPH

J. PLACARDS

In full view of the pilot:

"THIS AIRPLANE MUST BE OPERATED AS A NORMAL OR UTILITY CATEGORY AIRPLANE IN COMPLIANCE WITH THE OPERATING LIMITATIONS STATED IN THE FORM OF PLACARDS, MARKINGS AND MANUALS.

ALL MARKINGS AND PLACARDS ON THIS AIRPLANE APPLY TO ITS OPERATION AS A UTILITY CATEGORY AIRPLANE. FOR NORMAL AND UTILITY CATEGORY OPERATIONS, REFER TO THE AIRPLANE FLIGHT MANUAL.

NO ACROBATIC MANEUVERS ARE APPROVED FOR NORMAL CATEGORY OPERATIONS. SPINS ARE PROHIBITED FOR NORMAL AND UTILITY CATEGORIES."

In full view of the pilot, the following takeoff and landing check lists will be installed:

TAKEOFF CHECK LIST

Fuel on proper tank	Mixture set	Fasten belts/harness
Electric fuel pump on	Seat backs erect	Trim tab - set
Engine gauges checked		Controls - free
Flaps - set		Door - latched
Carb heat off		

1. On aircraft with ser. nos. 7415001 through 7515449.

LANDING CHECK LIST

Fuel on proper tank		Flaps - set (125 mph)
Mixture rich	Seat backs erect	Fasten belts/harness
Electric fuel pump on		

2. On aircraft with ser. nos. 7615001 and up.

LANDING CHECK LIST

Fuel on proper tank		Flaps - set (115 mph)
Mixture rich	Seat backs erect	Fasten belts/harness
Electric fuel pump on		

CHEROKEE WARRIOR

Adjacent to upper door latch:

"ENGAGE LATCH BEFORE FLIGHT."

On the instrument panel in full view of the pilot:

"DEMONSTRATED CROSSWING COMPONENT 20 MPH."

On inside of the baggage compartment door:

"BAGGAGE MAXIMUM 200 LBS"
"UTILITY CATEGORY OPERATION - NO BAGGAGE OR
AFT PASSENGERS ALLOWED. NORMAL CATEGORY
OPERATION - SEE AIRPLANE FLIGHT MANUAL WEIGHT
AND BALANCE SECTION FOR BAGGAGE AND AFT
PASSENGER LIMITATIONS."

In full view of the pilot:

"ROUGH AIR OR MANEUVERING SPEED - 124 MPH."

"UTILITY CATEGORY OPERATION - NO AFT PASSENGERS
ALLOWED."

On the instrument panel in full view of the pilot when the oil cooler winterization kit is installed:

"OIL COOLER WINTERIZATION PLATE TO BE REMOVED
WHEN AMBIENT TEMPERATURE EXCEEDS 50° F."

In full view of the pilot:

"UTILITY CATEGORY ONLY."

ACROBATIC MANEUVERS ARE LIMITED TO THE FOLLOWING:

	ENTRY SPEED
SPINS PROHIBITED	
STEEP TURNS	124 MPH
LAZY EIGHTS	124 MPH
CHANDELLES	124 MPH

On the instrument panel in full view of the pilot when the supplementary white strobe lights are installed:

"WARNING - TURN OFF STROBE LIGHTS WHEN TAXIING
IN VICINITY OF OTHER AIRCRAFT, OR DURING FLIGHT
THROUGH CLOUD, FOG OR HAZE."

SECTION II
PROCEDURES

1. The stall warning system is inoperative with the master switch off.
2. Electric fuel pump must be on for both landing and takeoff.
3. Intentional spins are prohibited. In the event that an unintentional spin is encountered, recovery can be accomplished by immediately using the following procedures:
 - a. THROTTLE - IDLE
 - b. AILERONS - NEUTRAL
 - c. RUDDER - FULL OPPOSITE TO DIRECTION OF ROTATION
 - d. CONTROL WHEEL - FULL FORWARD
 - e. RUDDER - NEUTRAL (WHEN ROTATION STOPS)
 - f. CONTROL WHEEL - AS REQUIRED TO SMOOTHLY REGAIN LEVEL FLIGHT ATTITUDE
4. Except as noted above, all operating procedures for this airplane are normal.

THIS PAGE INTENTIONALLY LEFT BLANK

SECTION III
PERFORMANCE

The following performance figures were obtained during FAA type tests and may be realized under conditions indicated with the airplane and engine in good condition and with average piloting technique. All performance is given for 2325 pounds.

Loss of altitude during stalls varied from 100 to 275 feet, depending on configuration and power.

Stalling speeds, in mph, power off, versus angle of bank (Calibrated Airspeed):

Angle of Bank	0°	20°	40°	50°	60°
Flaps Up	64.5	67	74	80	91
Flaps Down	58	60	66	72	82

CHEROKEE WARRIOR

THIS PAGE INTENTIONALLY LEFT BLANK

REPORT: VB-573 PAGE 3-8
MODEL: PA-28-151

FAA APPROVED JULY 25, 1973
REVISED: AUGUST 1, 1973

SECTION IV
OPTIONAL EQUIPMENT

NOTE

THE INFORMATION CONTAINED IN THIS SECTION
APPLIES WHEN THE RELATED EQUIPMENT IS INSTALLED
IN THE AIRCRAFT.

- A. Electric Pitch Trim Installation
- B. AutoFlite II Installation
- C. Installation of Piper AutoControl III and/or AutoControl IIIB

THIS PAGE INTENTIONALLY LEFT BLANK

A. ELECTRIC PITCH TRIM INSTALLATION

The following emergency information applies in case of electric pitch trim malfunction:

1. In case of malfunction, disengage electric pitch trim by pushing pitch trim switch on instrument panel to OFF position.
2. In an emergency, electric pitch trim may be overpowered using manual pitch trim.
3. In cruise configuration, malfunction results in 10° pitch change and 200 ft altitude variation.
4. In approach configuration, a malfunction can result in a 5° pitch change and 50 ft altitude loss.

THIS PAGE INTENTIONALLY LEFT BLANK

THIS PAGE INTENTIONALLY LEFT BLANK

CHEROKEE WARRIOR

THIS PAGE INTENTIONALLY LEFT BLANK

REPORT: VB-573 PAGE 3-14
MODEL: PA-28-151

FAA APPROVED AUGUST 30, 1973

B. AUTOFLITE II INSTALLATION

This supplement must be used in conjunction with the applicable FAA Approved Airplane Flight Manual when Piper AutoFlite II, Model AK430 is installed in accordance with STC SA1406SW or STC SA3066SW-D. The information contained herein supplements the information of the basic Airplane Flight Manual; for limitations, procedures and performance information not contained in this supplement, consult the basic Airplane Flight Manual.

1. LIMITATIONS

- a. Autopilot use prohibited above 170 MPH CAS.
- b. Autopilot OFF during takeoff and landing.

2. PROCEDURES

a. Normal Operation

(1) Engagement

- (a) Rocker switch on instrument panel - ON.
- (b) Interrupt switch on left hand side of pilot's control wheel - RELEASED.

(2) Disengagement

- (a) Depress interrupt switch on pilot's control wheel (or)
- (b) Rocker switch on instrument panel - OFF.

(3) Heading Changes

- (a) Depress interrupt switch, make heading change, release interrupt switch.
- (b) Move trim knob on instrument for drift correction from a constant heading.
- (c) Move turn command knob on instrument for right or left banked turns.

(4) OMNI Tracker

- (a) Center turn command knob and push IN to engage tracker.
- (b) Trim knob - push IN for high sensitivity.

b. Emergency Operation

- (1) In case of malfunction DEPRESS and hold interrupt switch on pilot's control wheel.
- (2) Rocker switch on instrument panel - OFF.
- (3) Unit may be overpowered manually.
- (4) In climb, cruise or descent configuration a malfunction with a 3 second delay in recovery initiation results in 60° bank and 320' altitude loss. Maximum altitude loss measured at 170 MPH CAS in a descent.
- (5) In approach configuration a malfunction with a 1 second delay in recovery initiation results in 15° bank and 20' altitude loss.

3. PERFORMANCE

No change.

CHEROKEE WARRIOR

THIS PAGE INTENTIONALLY LEFT BLANK

REPORT: VB-573 PAGE 3-16
MODEL: PA-28-151

FAA APPROVED AUGUST 30, 1973

C. INSTALLATION OF PIPER AUTOCONTROL III AND/OR AUTOCONTROL IIIB

1. LIMITATIONS

- a. Autopilot OFF during takeoff and landing.
- b. Autopilot use prohibited above 140 MPH CAS.

2. PROCEDURES

a. PREFLIGHT

(1) Roll Section

- (a) Place Radio Coupler in "Heading" mode and place A/P ON/OFF switch in the "ON" position to engage roll section. Rotate roll command knob Left and Right and observe control wheel describes a corresponding Left and Right turn, then center knob.
- (b) Set proper D.G. Heading on D.G. and turn Heading Indice to aircraft heading. Engage "Heading" mode switch and rotate Heading Indice right and left. Aircraft control wheel should turn same direction as Indice. While D.G. indice is set for a left turn, grasp control wheel and override the servo to the right. Repeat in opposite direction for right turn.
- (c) If VOR signal available check Omni mode on Radio Coupler by swinging Omni needle left and right slowly. Observe that control wheel rotates in direction of needle movement.
- (d) Disengage by placing the A/P ON/OFF switch to the "OFF" position.

b. IN-FLIGHT

- (1) Trim airplane (ball centered).
- (2) Check air pressure or vacuum to ascertain that the Directional Gyro and Attitude Gyro are receiving sufficient air.
- (3) Roll Section
 - (a) To engage, center Roll Command Knob, place the A/P ON/OFF switch to the "ON" position. To turn rotate roll command knob in desired direction. (Maximum angle of bank should not exceed 30°.)
 - (b) For heading mode, set Directional Gyro with Magnetic Compass. Push directional gyro HDG knob in, rotate to aircraft heading. Place the console HDG ON/OFF switch to the "ON" position. To select a new aircraft heading, push D.G. heading knob IN and rotate, in desired direction of turn, to the desired heading.

NOTE

In HDG mode the maximum bank angles are limited to approximately 20° and single command, heading changes should be limited to 150°. (HDG Indice not more than 150° from actual aircraft heading.)

(4) VOR

(a) To Intercept:

1. Using OMNI Bearing Selector, dial desired course, inbound or outbound.
2. Set identical heading on Course Selector D.G.
3. After aircraft has stabilized, position coupler mode selector knob to OMNI mode. As aircraft nears selected radial, interception and crosswind correction will be automatically accomplished without further switching.

NOTE

If aircraft position is less than 45° from selected radial, aircraft will intercept before station. If position is more than 45°, interception will occur after station passage. As the aircraft nears the OMNI station, (1/2 mile) the zone of confusion will direct an "S" turn in alternate directions as the OMNI indicator needle swings. This alternate banking limited to the standard D.G. bank angle, is an indication of station passage.

(b) To select new course:

1. To select a new course or radial, rotate the HDG indice to the desired HDG (match course).
2. Rotate OBS to the new course. Aircraft will automatically turn to the intercept heading for the new course.

(c) To change stations:

1. If same course is desired, merely tune receiver to new station frequency.
2. If different course is desired, position coupler mode selector to HDG mode. Dial course selector D.G. to new course. Dial OBS to new course and position coupler mode selector to OMNI mode.

(5) VOR Approach

Track inbound to station as described in VOR navigation section.

After station passage:

- (a) Dial outbound course on Course Selector D.G., then dial same course on OBS.
- (b) After established on outbound radial, position coupler mode selector to HDG mode and select outbound procedure turn heading. After 40 seconds to 1 minute select a turn in the desired direction with the Course Selector D.G. to the inbound procedure turn heading.
- (c) Set OBS to inbound course.
- (d) When aircraft heading is 45° to the inbound course, dial Course Selector D.G. to inbound course and position coupler mode selector to OMNI mode.

NOTE

For precise tracking over OMNI station, without "S" turn, position coupler mode selector to HDG mode just prior to station passage. If holding pattern is desired, position coupler mode selector to HDG mode at station passage inbound and select outbound heading in direction of turn. After elapsed time, dial inbound course on Course Selector D.G. When aircraft heading is 45° to radial, position coupler mode selector to OMNI mode.

(6) LOC Approach Only

- (a) To intercept dial ILS outbound course on Course Selector D.G. When stabilized, position coupler mode selector to LOC REV mode.
- (b) After interception and when beyond outer marker, position coupler mode selector to HDG mode and dial outbound procedure turn heading. After one minute, dial inbound procedure turn heading in direction of turn.
- (c) When aircraft heading is 45° to ILS inbound course dial inbound course on Course Selector D.G. and position coupler mode selector to LOC NORM mode.
- (d) At the missed approach point (M.A.P.), or when missed approach is elected, position coupler mode selector to HDG mode and execute missed approach procedure.

(7) LOC Approach - Back Course (Reverse)

- (a) To intercept dial ILS Back Course outbound heading on Course Selector D.G. When stabilized, position coupler mode selector to LOC NORM mode.
- (b) After interception and when beyond fix, position coupler mode selector to HDG and dial outbound procedure turn heading. After one minute, dial inbound procedure turn heading in direction of turn.
- (c) When heading 45° to inbound course, dial inbound course on Course Selector D.G. and position coupler mode selector to LOC REV mode.
- (d) Approximately 1/2 mile from runway, position coupler mode selector to HDG mode to prevent "S" turn over ILS station near runway threshold.
- (e) Missed approach - same as Front Course. (See (6) d)

CHEROKEE WARRIOR

c. EMERGENCY OPERATION

- (1) In an emergency the AutoControl can be disconnected by placing the A/P ON/OFF switch to the OFF position.
- (2) The AutoControl can be overpowered at either control wheel.
- (3) An Autopilot runaway, with a 3 second delay in the initiation of recovery, while operating in a climb, cruise or descending flight could result in a 60° bank and 100 foot altitude loss.
- (4) An Autopilot runaway, with a 1 second delay in the initiation of recovery, during an approach operation, coupled or uncoupled, could result in a 10° bank and 100 foot altitude loss.

3. PERFORMANCE

No change.

**F.A.A. APPROVED
EMERGENCY PROCEDURES**

NONE APPLICABLE TO THIS AIRPLANE

Faint, illegible text at the bottom left corner, possibly bleed-through from the reverse side of the page.

X

EMERGENCY PROCEDURES

Introduction	4-1
Engine Power Loss During Takeoff	4-1
Engine Power Loss In Flight	4-2
Power Off Landing	4-2
Spins	4-3
Open Door	4-3
Fire	4-4
Loss of Oil Pressure	4-5
Loss of Fuel Pressure	4-5
High Oil Temperature	4-5
Alternator Failure	4-6
Engine Roughness	4-6



Faint, illegible text or markings at the bottom left of the page.

Small, illegible text or markings at the bottom left of the page.

Faint, illegible text or markings at the bottom center of the page.

X

EMERGENCY PROCEDURES

Introduction	4-1
Engine Power Loss During Takeoff	4-1
Engine Power Loss In Flight	4-2
Power Off Landing	4-2
Spins	4-3
Open Door	4-4
Fire	4-5
Loss of Oil Pressure	4-5
Loss of Fuel Pressure	4-5
High Oil Temperature	4-6
Alternator Failure	4-6
Engine Roughness	4-6



EMERGENCY PROCEDURES

INTRODUCTION

This section contains procedures that are recommended if an emergency condition should occur during ground operation, takeoff, or in flight. These procedures are suggested as the best course of action for coping with the particular condition described, but are not a substitute for sound judgment and common sense. Since emergencies rarely happen in modern aircraft, their occurrence is usually unexpected, and the best corrective action may not always be obvious. Pilots should familiarize themselves with the procedures given in this section and be prepared to take appropriate action should an emergency arise.

Most basic emergency procedures, such as power off landings, are a part of normal pilot training. Although these emergencies are discussed here, this information is not intended to replace such training, but only to provide a source of reference and review, and to provide information on procedures which are not the same for all aircraft. It is suggested that the pilot review standard emergency procedures periodically to remain proficient in them.

ENGINE POWER LOSS DURING TAKEOFF

The proper action to be taken if loss of power occurs during takeoff will depend on circumstances.

1. If sufficient runway remains for a normal landing, land straight ahead.
2. If insufficient runway remains, maintain a safe airspeed and make only a shallow turn if necessary to avoid obstructions. Use of flaps depends on circumstances. Normally, flaps should be fully extended for touchdown.
3. If you have gained sufficient altitude to attempt a restart, proceed as follows:
 - a. MAINTAIN SAFE AIRSPEED
 - b. FUEL SELECTOR - SWITCH TO ANOTHER TANK CONTAINING FUEL
 - c. ELECTRIC FUEL PUMP - CHECK ON
 - d. MIXTURE - CHECK RICH
 - e. CARBURETOR HEAT - ON

NOTE

If engine failure was caused by fuel exhaustion, power will not be regained after tanks are switched until empty fuel lines are filled, which may require up to ten seconds.

If power is not regained, proceed with the POWER OFF LANDING procedure.

ENGINE POWER LOSS IN FLIGHT

Complete engine power loss is usually caused by fuel flow interruption, and power will be restored shortly after fuel flow is restored. If power loss occurs at low altitude, the first step is to prepare for an emergency landing (See POWER OFF LANDING). Maintain an airspeed of at least 85 MPH, and if altitude permits, proceed as follows:

1. Fuel Selector - Switch to another tank containing fuel.
2. Electric Fuel Pump - On
3. Mixture - Rich
4. Carburetor Heat - On
5. Engine Gauges - Check for indication of the cause of power loss.
6. Primer - Check locked
7. If no fuel pressure is indicated, check tank selector position to be sure it is on a tank containing fuel.

When power is restored:

8. Carburetor Heat - Off
9. Electric Fuel Pump - Off

If the above steps do not restore power, prepare for an emergency landing.

If time permits:

1. Ignition Switch - "L" then "R" then back to "BOTH."
2. Throttle and Mixture - Different settings. (This may restore power if the problem is too rich or too lean a mixture, or partial fuel system restriction.)
3. Try another fuel tank. (Water in the fuel could take some time to be used up, and allowing the engine to windmill may restore power. If power loss is due to water, fuel pressure indications will be normal.)

NOTE

If engine failure was caused by fuel exhaustion, power will not be restored after tanks are switched until empty fuel lines are filled, which may require up to ten seconds.

If power is not restored, proceed with POWER OFF LANDING procedure.

POWER OFF LANDING

If loss of power occurs at altitude, trim the aircraft for best gliding angle 85 MPH, and look for a suitable field. If measures taken to restore power are not effective, and if time permits, check your charts for airports in the immediate vicinity; it may be possible to land at one if you have sufficient altitude. If possible, notify the FAA by radio of your difficulty and intentions. If another pilot or passenger is aboard, let them help.

When you have located a suitable field, establish a spiral pattern around this field. Try to be 1000 feet above the field at the downwind position to make a normal approach. When the field can easily be reached, slow up to 76 MPH for the shortest landing. Excess altitude may be lost by widening your pattern, using flaps or slipping, or a combination of these.

Touchdowns should normally be made at the lowest possible airspeed, with full flaps.

When committed to landing:

1. Ignition - Off
2. Master Switch - Off
3. Fuel Selector - Off
4. Mixture - Idle Cut-Off
5. Seat Belt tight and Shoulder Harness in place.

SPINS

Intentional spins are prohibited in this aircraft. If a spin is inadvertently entered, immediately use the following recovery procedures:

1. THROTTLE - IDLE
2. RUDDER - FULL OPPOSITE TO DIRECTION OF ROTATION
3. CONTROL WHEEL - FULL FORWARD
4. RUDDER - NEUTRAL (WHEN ROTATION STOPS)
5. CONTROL WHEEL - AS REQUIRED TO SMOOTHLY REGAIN LEVEL FLIGHT ATTITUDE

OPEN DOOR

The cabin door on the Cherokee Warrior is double latched, so the chances of it springing open in flight at both the top and bottom are remote. However, should you forget the upper latch, or not engage the lower latch, the door may spring partially open. This will usually happen at takeoff or soon afterward. An open door will not affect normal flight characteristics, and a normal landing can be made with the door open.

If both upper and lower latches open, the door will trail slightly open, and airspeed will be reduced slightly.

To close the door in flight, proceed as follows:

1. Slow aircraft to 100 MPH.
2. Cabin Vents - Close
3. Storm Window - Open
4. If upper latch is open - latch. If lower latch is open - open top latch, push door further open, and then close rapidly. Latch top latch.

A slip in the direction of the open door will assist in latching procedure.

CHEROKEE WARRIOR

FIRE

The presence of fire is noted through smoke, smell, and heat in the cabin. It is essential that the source of the fire be promptly identified through instrument readings, character of the smoke, or other indications, since the action to be taken differs somewhat in each case.

1. Source of Fire - Check
 - a. Electrical Fire (Smoke in Cabin):
 - (1) Master Switch - Off
 - (2) Vents - Open
 - (3) Cabin Heat - Off
 - (4) Land as soon as practicable.
 - b. Engine Fire:
 - (1) In case of engine fire in flight
 - (a) Fuel Selector - OFF
 - (b) Throttle - CLOSE
 - (c) Mixture - IDLE CUT OFF
 - (d) Heater - Off (In all cases of fire)
 - (e) Defroster - OFF (In all cases of fire)
 - (f) If terrain permits - Land Immediately

The possibility of an engine fire in flight is extremely remote. The procedure given above is general and pilot judgment should be the deciding factor for action in such an emergency.

- (2) In case of engine fire on the ground
 - (a) If engine has not started
 1. Mixture - IDLE CUT-OFF
 2. Throttle - OPEN
 3. Turn engine with starter (This is an attempt to pull the fire into the engine.)
 - (b) If engine has already started and is running, continue operating to try pulling the fire into the engine.
 - (c) In either case stated in (a) and (b), if the fire continues longer than a few seconds, the fire should be extinguished by the best available external means.
 - (d) If external fire extinguishing is to be applied
 1. Fuel Selector Valve - OFF
 2. Mixture - IDLE CUT-OFF

LOSS OF OIL PRESSURE

Loss of oil pressure may be either partial or complete. A partial loss of oil pressure usually indicates a malfunction in the oil pressure regulating system, and a landing should be made as soon as possible to investigate the cause and prevent engine damage.

A complete loss of oil pressure indication may signify oil exhaustion or may be the result of a faulty gauge. In either case, proceed toward the nearest airport, and be prepared for a forced landing. If the problem is not a pressure gauge malfunction, the engine may stop suddenly. Maintain altitude until such time as a dead stick landing can be accomplished. Don't change power settings unnecessarily, as this may hasten complete power loss.

Depending on the circumstances, it may be advisable to make an off airport landing while power is still available, particularly if other indications of actual oil pressure loss, such as sudden increase in temperatures, or oil smoke, are apparent, and an airport is not close.

If engine stoppage occurs, proceed to POWER OFF LANDING.

LOSS OF FUEL PRESSURE

1. Electric Boost Pump - On
2. Fuel Selector - Check on full tank

If problem is not an empty fuel tank, land as soon as practical and have the fuel system checked.

HIGH OIL TEMPERATURE

An abnormally high oil temperature indication may be caused by a low oil level, an obstruction in the oil cooler, damaged or improper baffle seals, a defective gauge, or other causes. Land as soon as practical at an appropriate airport and have the cause investigated.

A steady, rapid rise in oil temperature is a sign of trouble. Land at the nearest airport and let a mechanic investigate the problem. Watch the oil pressure gauge for an accompanying loss of pressure.

CHEROKEE WARRIOR

ALTERNATOR FAILURE

Loss of alternator output is detected through a zero reading on the ammeter. Before executing the following procedure, insure that the reading is zero and not merely low by actuating an electrically powered device, such as the landing light. If no increase in the ammeter reading is noted, alternator failure can be assumed.

1. Reduce electrical load.
2. Alternator Circuit Breakers - Check
3. "Alt" Switch - Off (for 1 second), then On

If the ammeter continues to indicate no output, or alternator will not stay reset, turn off "Alt" switch, maintain minimum electrical load, and land as soon as practical. All electrical power is being supplied by the battery.

ENGINE ROUGHNESS

Engine roughness is usually due to carburetor icing which is indicated by a drop in RPM, and may be accompanied by a slight loss of airspeed or altitude. If too much ice is allowed to accumulate, restoration of full power may not be possible; therefore, prompt action is required.

1. Carburetor heat - on (See Note). RPM will decrease slightly and roughness will increase. Wait for a decrease in engine roughness or an increase in RPM, indicating ice removal. If no change in approximately one minute, return carburetor heat to OFF. If the engine is still rough, try steps below.
 - a. Mixture - Adjust for maximum smoothness. Engine will run rough if too rich or too lean.
 - b. Electric Fuel Pump - On
 - c. Fuel Selector - Change to other tank to see if fuel contamination is the problem.
 - d. Engine Gauges - Check for abnormal readings. If any gauge readings are abnormal, proceed accordingly.
 - e. Magneto Switch - "L" then "R" then back to "BOTH." If operation is satisfactory on either magneto, proceed on that magneto at reduced power, with mixture full rich, to a landing at the first available airport.

If roughness persists, prepare for a precautionary landing at pilot's discretion.

NOTE

Partial carburetor heat may cause partial melting of ice which will refreeze in the intake system; therefore when using carburetor heat, always use full heat and when ice is removed return to the full cold position.

WEIGHT AND BALANCE

Log of Revisions	5-iii
Weight and Balance	5-1
Weight and Balance Data - Weighing Procedure	5-3
Weight and Balance Data	5-7
C. G. Range and Weight Instructions	5-8
Equipment List	5-11

1947
1948
1949
1950
1951
1952
1953
1954
1955
1956
1957
1958
1959
1960
1961
1962
1963
1964
1965
1966
1967
1968
1969
1970
1971
1972
1973
1974
1975
1976
1977
1978
1979
1980
1981
1982
1983
1984
1985
1986
1987
1988
1989
1990
1991
1992
1993
1994
1995
1996
1997
1998
1999
2000
2001
2002
2003
2004
2005
2006
2007
2008
2009
2010
2011
2012
2013
2014
2015
2016
2017
2018
2019
2020
2021
2022
2023
2024
2025
2026
2027
2028
2029
2030

WEIGHT AND BALANCE

FOR

CHEROKEE WARRIOR

APPLICABLE TO AIRCRAFT SERIAL NUMBERS 28-7415001 THROUGH 28-7615435

WARNING

EXTREME CARE MUST BE EXERCISED TO LIMIT THE USE OF THIS REPORT TO APPLICABLE AIRCRAFT. THIS REPORT REVISED AS INDICATED BELOW OR SUBSEQUENTLY REVISED IS VALID FOR USE WITH THE AIRPLANE IDENTIFIED BELOW WHEN APPROVED BY PIPER AIRCRAFT CORPORATION. SUBSEQUENT REVISIONS SUPPLIED BY PIPER AIRCRAFT CORPORATION MUST BE PROPERLY INSERTED.

MODEL PA-28-151

AIRCRAFT SERIAL NO. _____ REGISTRATION NO. _____

WEIGHT AND BALANCE, REPORT NUMBER VB-535 REVISION _____

PIPER AIRCRAFT CORPORATION
APPROVAL SIGNATURE AND STAMP _____

ISSUED: MAY 14, 1973
REVISED: OCTOBER 21, 1977

REPORT: VB-535
MODEL: PA-28-151

1954

1955

1956

INDEX - WEIGHT AND BALANCE

Log of Revisions	5-iii
Weight and Balance	5-1
Weight and Balance Data - Weighing Procedure	5-3
Weight and Balance Data	5-7
C. G. Range and Weight Instructions	5-8
Equipment List	5-11
A. Propeller and Propeller Accessories	5-11
B. Engine and Engine Accessories	5-12
C. Landing Gear and Brakes	5-13
D. Electrical Equipment	5-14
E. Instrument	5-15
F. Miscellaneous	5-16
G. Engine and Engine Accessories (Optional Equipment)	5-17
H. Electrical Equipment (Optional Equipment)	5-18
I. Instruments (Optional Equipment)	5-20
J. Autopilots (Optional Equipment)	5-21
K. Radio Equipment (Optional Equipment)	5-22
L. Miscellaneous (Optional Equipment)	5-26

THIS PAGE INTENTIONALLY LEFT BLANK

WEIGHT AND BALANCE LOG OF REVISIONS

Revision	Revised Pages	Description and Revision	Approved Date
1	5-8	Revised Arm and Moment values and Fuel capacity for Sample Loading Problem.	<i>V. Tennant</i> Aug. 30, 1973
2	5-10 5-17 5-27	Revised C.G. Range and Weight Chart. Added Vacuum Pump (79399-0). Revised Ground Ventilating Blower.	<i>om</i> Jan. 25, 1974
3	Title	Added PAC Approval Form. (NOTE: AIRCRAFT DELIVERED WITH MANUALS PRIOR TO THIS REVISION DO NOT REQUIRE THIS REVISION.)	May 31, 1974 <i>om</i>
4	5-5, 5-7 5-12 5-13 5-14 5-16 5-17 5-18 5-19 5-20 5-21 5-22 5-23 5-24 5-25 5-25a 5-25b	Revised Unusable Fuel Moment (graph). Revised Engine Driven Fuel Pump and Prestolite Starter Cert. Basis; added Chrysler Alternator; added Oil Filters and footnote. Revised Landing Gear Cert. Basis. Revised Battery Weight, Arm and Moment; added Annunciator Lights and footnote. Revised Inertia Safety Belts Weights, Moment and part no. Added Lycoming LW13743, Champion (H-48110) Oil Filter; revised Vacuum Regulator Weight and Moment; revised Prestolite Starter Cert. Basis; added Low Vacuum Annunciator Lights, Airborne Vacuum Regulator and footnotes. Revised Battery Weight, Arm and Moment. Revised Red Strobe Light Cert. Basis. Added Encoding Altimeter and footnote. Revised AutoControl III; added AutoControl IIIB and footnotes. Revised King VHF Transceivers; added footnote. Added footnote. Revised UGR-2A Glide Slope; added footnote. Revised Narco Marker Beacon and King Audio Panel; added footnote. Added Page. Added Page.	

ISSUED: MAY 14, 1973
REVISED: JUNE 14, 1974

REPORT: VB-535 PAGE 5-iii
MODEL: PA-28-151

WEIGHT AND BALANCE LOG OF REVISIONS (cont)

Revision	Revised Pages	Description and Revision	Approved Date
4 (cont)	5-26	Revised Inertia Safety Belts part no.; revised Main Wheel Fairings and Adjustable Front Seats Weight, Arm and Moment; added Assist Strap.	<i>R. Haulin</i> June 14, 1974
	5-27	Added Corrosive Resistant Kit.	
5	5-15	Revised Engine Cluster Dwg. No.	<i>C. E. Rickli</i> Jan. 17, 1975
	5-26	Revised Fire Extinguisher Weight and Moment; deleted Baggage Tie Down Straps.	
	5-27	Added Overhead Vent Systems (76304-9 and 76304-10).	
6	5-15	Revised Airspeed Indicator info; added footnotes.	<i>M. J. Johnson</i> July 14, 1975
	5-18	Revised Rotating Beacon; revised Piper Pitch Trim Dwg. No.; added 67496-3 and footnote.	
	5-20	Revised Tru-Speed Indicator info.; added Engine Hour Meter; added footnotes.	
	5-21	Revised AutoFlite II, AutoControl IIIB and Omni Coupler Cert. Basis; added footnotes.	
	5-26	Added 79591-0 (Left) Vert. Adj. Front Seats; added 79591-1 (Right) Vert. Adj. Front Seat.	
	5-27	Added Stainless Steel Control Cables; relocated Exterior Finish to page 5-28.	
	5-28	Added Exterior Finish from page 5-27.	
7	5-20	Revised Clock.	<i>C. E. Rickli</i> Dec. 1, 1975
	5-25	Revised Automatic Locator Transmitter	
	5-25a	Added King KN61 and KN65A DME's.	
8	5-25	Added Automatic Locator Transmitter; moved info to page 5-25a.	<i>C. E. Rickli</i> July 20, 1976
	5-25a	Added info from page 5-25.	
9	Title	Added Applicable Serial Numbers. (NOTE: AIRCRAFT DELIVERED WITH MANUALS PRIOR TO THIS REVISION DO NOT REQUIRE THIS REVISION.)	<i>C. E. Rickli</i> Oct. 21, 1977

WEIGHT AND BALANCE LOG OF REVISIONS (cont)

Revision	Revised Pages	Description of Revision	Approved Date
10	5-1 5-3 5-4	Revised Weight and Balance info. Added Caution; relocated para. 2.b. to pg. 5-4 Added para. 2.b. from pg. 5-3.	<i>R. Kennedy</i> April 6, 1979
11	5-12	Added Oil Cooler alternate vendor info.	<i>W. Sample</i> Nov. 10, 1988

ISSUED: APRIL 6, 1979
 REVISED: NOVEMBER 7, 1988

REPORT: VB-535 PAGE 5-v
 MODEL: PA-28-151

THIS PAGE INTENTIONALLY LEFT BLANK

WEIGHT AND BALANCE

In order to achieve the performance and flying characteristics which are designed into the airplane, it must be flown with the weight and center of gravity (C.G.) position within the approved envelope. The aircraft offers a tremendous flexibility of loading. However, you cannot fill the airplane, with the maximum number of adult passengers, full fuel tanks and maximum baggage. With the flexibility comes responsibility. The pilot must insure that the airplane is loaded within the loading envelope before he makes a takeoff.

Misloading carries consequences for any aircraft. An overloaded airplane will not take off, climb or cruise as well as a properly loaded one. The heavier the airplane is loaded, the less climb performance it will have.

Center of gravity is a determining factor in flight characteristics. If the C.G. is too far forward in any airplane, it may be difficult to rotate for takeoff or landing. If the C.G. is too far aft, the airplane may rotate prematurely on takeoff or try to pitch up during climb. Longitudinal stability will be reduced. This can lead to inadvertent stalls and even spins; and spin recovery becomes more difficult as the center of gravity moves aft of the approved limit.

A properly loaded aircraft, however, will perform as intended. Before the airplane is delivered, it is weighed, and a basic weight and C.G. location is computed. (Basic weight consists of the empty weight of the aircraft plus the unusable fuel and full oil capacity.) Using the basic weight and C.G. location, the pilot can easily determine the weight and C.G. position for the loaded airplane by computing the total weight and moment and then determining whether they are within the approved envelope.

The basic weight and C.G. location for a particular airplane are recorded in the weight and balance section of the Airplane Flight Manual. The current values should always be used. Whenever new equipment is added or any modification work is done, the mechanic responsible for the work is required to compute a new basic weight and basic C.G. position and to write these in the aircraft log book. The owner should make sure that it is done.

A weight and balance calculation is necessary in determining how much fuel or baggage can be boarded so as to keep within allowable limits. Check calculations prior to adding fuel to insure against improper loading.

The following pages are forms used in weighing an airplane in production and in computing basic weight, basic C.G. position, and useful load. Note that the useful load includes fuel, oil, baggage, cargo and passengers. Following this is the method for computing takeoff weight and C.G.

THIS PAGE INTENTIONALLY LEFT BLANK

WEIGHT AND BALANCE DATA

WEIGHING PROCEDURE

At the time of delivery, Piper Aircraft Corporation provides each airplane with the licensed empty weight and center of gravity location. This data is on Page 5-7.

The removal or addition of an excessive amount of equipment or excessive airplane modifications can affect the licensed empty weight and empty weight center of gravity. The following is a weighing procedure to determine this licensed empty weight and center of gravity location:

1. PREPARATION

- a. Be certain that all items checked in the airplane equipment list are installed in the proper location in the airplane.
- b. Remove excessive dirt, grease, moisture, foreign items such as rags and tools from the airplane before weighing.
- c. Defuel airplane. Then open all fuel drains until all remaining fuel is drained. Operate engine on each tank until all undrainable fuel is used and engine stops.

CAUTION

Whenever the fuel system is completely drained and fuel is replenished it will be necessary to run the engine for a minimum of 3 minutes at 1000 RPM on each tank to insure no air exists in the fuel supply lines.

- d. Drain all oil from the engine, by means of the oil drain, with the airplane in ground attitude. This will leave the undrainable oil still in the system. Engine oil temperature should be in the normal operating range before draining.
- e. Place pilot and copilot seats in fourth (4th) notch, aft of forward position. Put flaps in the fully retracted position and all control surfaces in the neutral position. Tow bar should be in the proper location and all entrance and baggage doors closed.
- f. Weigh the airplane inside a closed building to prevent errors in scale readings due to wind.

2. LEVELING

- a. With airplane on scales, block main gear oleo pistons in the fully extended position.

ISSUED: MAY 14, 1973
REVISED: APRIL 6, 1979

REPORT: VB-535 PAGE 5-3
MODEL: PA-28-151

CHEROKEE WARRIOR

- b. Level airplane (see diagram) deflating nose wheel tire, to center bubble on level.

3. WEIGHING - AIRPLANE EMPTY WEIGHT

- a. With the airplane level and brakes released, record the weight shown on each scale. Deduct the tare, if any, from each reading.

Scale Position and Symbol	Scale Reading	Tare	Net Weight
Nose Wheel (N)			
Right Main Wheel (R)			
Left Main Wheel (L)			
Airplane Empty Weight, as Weighed (T)			

4. EMPTY WEIGHT CENTER OF GRAVITY

- a. The following geometry applies to the PA-28-151 airplane when airplane is level (See Item 2).

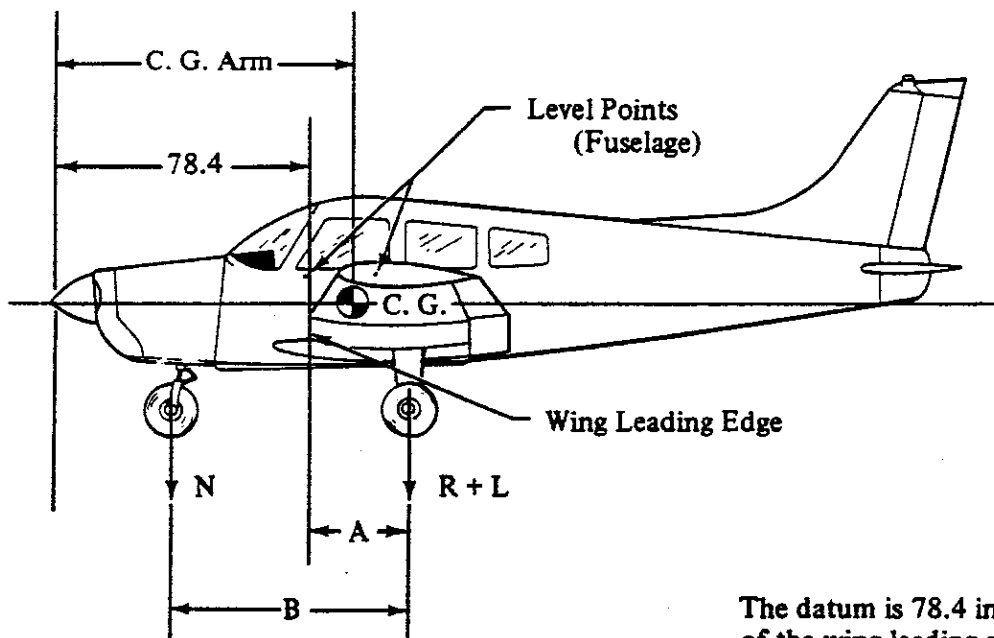

A =

B =

The datum is 78.4 inches ahead of the wing leading edge at the intersection of the straight and tapered section.

WEIGHT AND BALANCE DATA

MODEL PA-28-151 CHEROKEE

Airplane Serial Number _____

Registration Number _____

Date _____

AIRPLANE EMPTY WEIGHT

Item		Weight (Lbs)	× C. G. Arm (Inches Aft of Datum)	= Moment (In-Lbs)
*Empty Weight	Actual Computed			
Unusable Fuel (2 gal.)		12	103	1236
Standard Empty Weight				
Optional Equipment				
Licensed Empty Weight				

*Empty weight is defined as dry empty weight (including paint and hydraulic fluid) plus 1.8 lbs undrainable engine oil.

AIRPLANE USEFUL LOAD

$$(\text{Gross Weight}) - (\text{Licensed Empty Weight}) = \text{Useful Load}$$

Normal Category: (2325 lbs) - (lbs) = lbs

Utility Category: (1950 lbs) - (lbs) = lbs

THIS LICENSED EMPTY WEIGHT, C. G. AND USEFUL LOAD ARE FOR THE AIRPLANE AS DELIVERED FROM THE FACTORY. REFER TO APPROPRIATE AIRCRAFT RECORD WHEN ALTERATIONS HAVE BEEN MADE.

ISSUED: MAY 14, 1973
 REVISED: JUNE 14, 1974

REPORT: VB-535 PAGE 5-7
 MODEL: PA-28-151

C. G. RANGE AND WEIGHT INSTRUCTIONS

1. Add the weight of all items to be loaded to the licensed empty weight.
2. Use the loading graph to determine the moment of all items to be carried in the airplane.
3. Add the moment of all items to be loaded to the licensed empty weight moment.
4. Divide the total moment by the total weight to determine the C.G. location.
5. By using the figures of Item 1 and Item 4, locate a point on the C.G. range and weight graph. If the point falls within the C.G. envelope, the loading meets the weight and balance requirements.

SAMPLE LOADING PROBLEM (Normal Category)

	Weight (Lbs)	Arm Aft Datum (Inches)	Moment (In-Lbs)
Licensed Empty Weight			
Oil (8 quarts)	15	27.5	413
Pilot and Front Passenger	340	80.5	27370
Passengers, Aft* (Rear Seat)	340	118.1	40154
Fuel (48 Gal. Maximum)		95.0	
Baggage*		142.8	
Total Loaded Airplane			

The center of gravity (C.G.) of this sample loading problem is at _____ inches aft of the datum line. Locate this point () on the C.G. range and weight graph. Since this point falls within the weight - C.G. envelope, this loading meets the weight and balance requirements.

IT IS THE RESPONSIBILITY OF THE PILOT AND AIRCRAFT OWNER TO INSURE THAT THE AIRPLANE IS LOADED PROPERLY.

*Utility Category Operation - No baggage or aft passengers allowed.

LOADING GRAPH

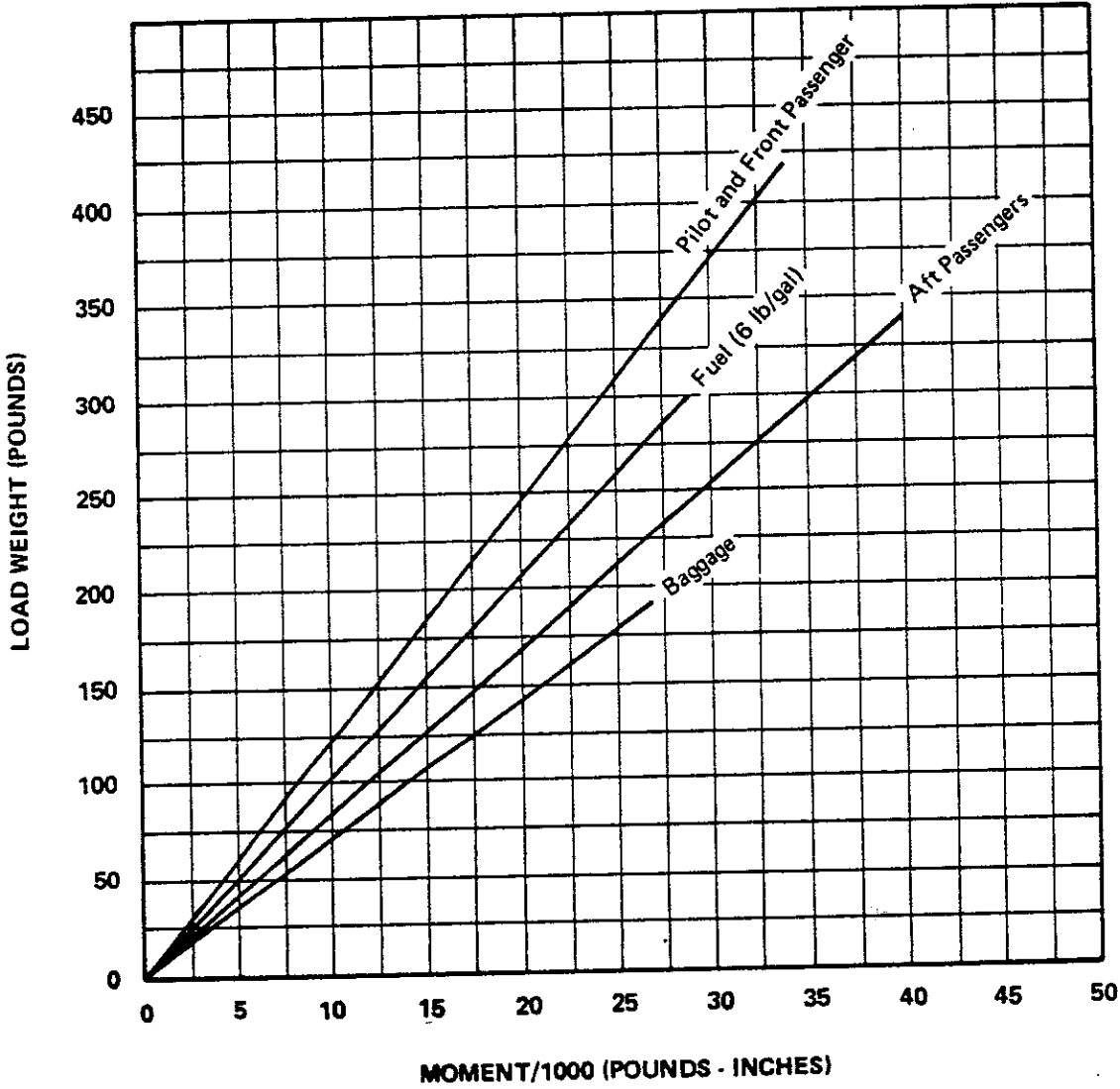

C. G. RANGE AND WEIGHT

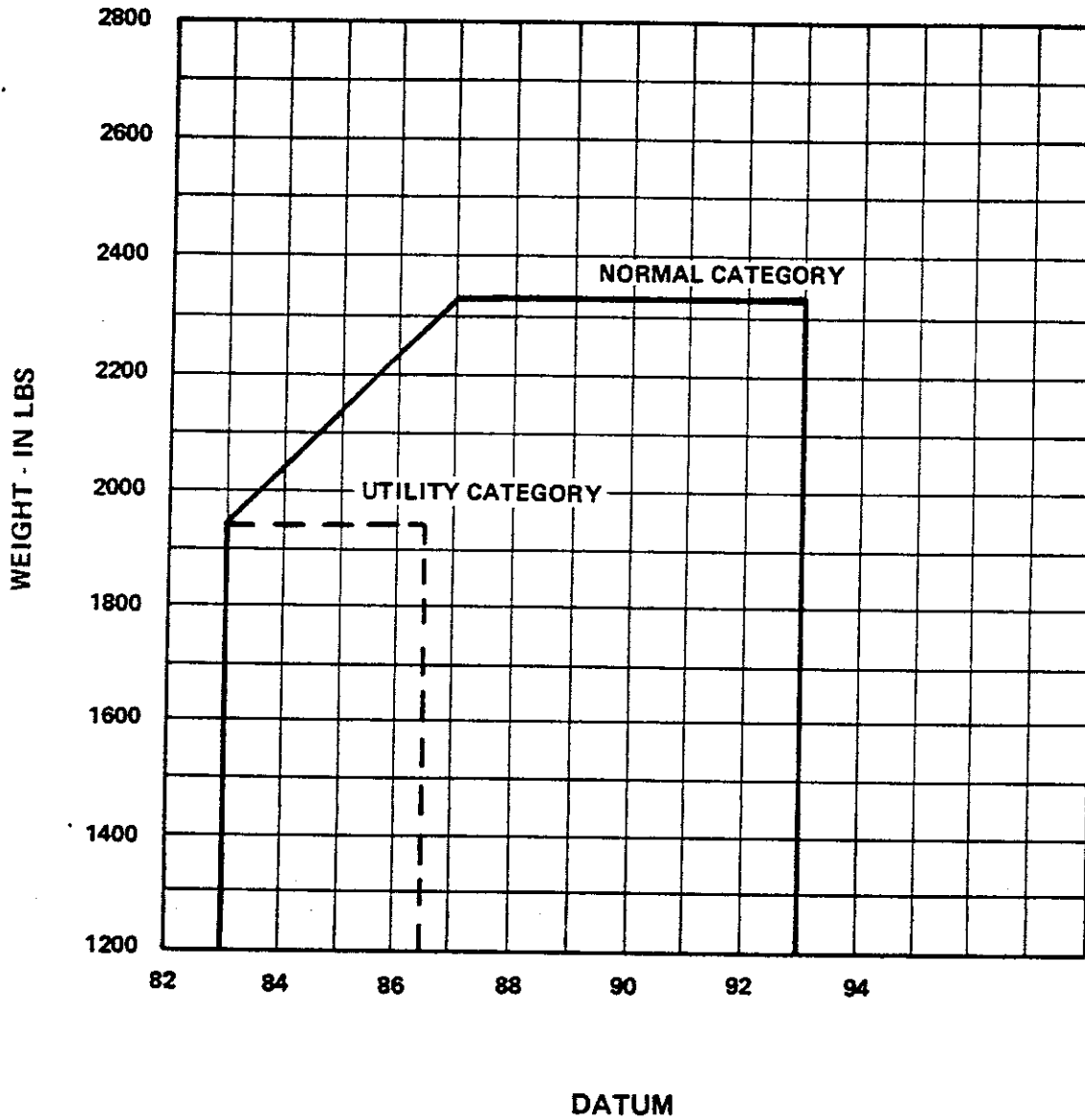

EQUIPMENT LIST

The following is a list of equipment which may be installed in the PA-28-151. Items marked with an "X" are items installed when the airplane was delivered by the manufacturer.

Item	Item	Weight Lbs.	Arm Aft Datum	Moment	Cert. Basis
A. Propeller and Propeller Accessories					
_____	Propeller, Sensenich 74DM6-0-58	31.6	3.8	120	TC P886
_____	or McCauley 1C1 60EGM7653	30.6	3.8	116	TC P910
_____	Spinner and Attachment Plates	2.5	3.0	7	TC 2A13

CHEROKEE WARRIOR

Item	Item	Weight Lbs.	Arm Aft Datum	Moment	Cert. Basis
B. Engine and Engine Accessories					
_____	Engine - Lycoming Model O-320-E3D	268.0	21.2	5682	TC 274
_____	Fuel Pump, Electric Auxiliary, Bendix Model 478360	1.6	44.7	72	TC 2A13
_____	Fuel Pump, Engine Driven, Lycoming Dwg. No. 73297, 74082, 75148 or 75246	1.7	36.3	62	TC 2A13
_____	Oil Cooler, Piper Dwg. 18622 Harrison *C-8526250	1.9	31.3	58	TC 2A13
_____	Air Filter, Piper Dwg. 35477	.4	30.0	12	TC 2A13
_____	Alternator, 60 Amp, Prestolite No. ALY6408	10.5	14.0	147	TC 2A13
_____	Starter - Lycoming 76210 (Prestolite MZ4204)	* 17.0	14.5	246	TC 2A13
_____	Alternator 60 Amp (Chrysler 3656623)	12.4	14.0	174	TC 2A13
_____	Oil Filter - Lycoming No. ** 75528 (AC *OF5578770)	3.3	35.5	117	TC 2A13
_____	Oil Filter - Lycoming** * LW-13743 (Champion * CH-48110)	2.8	35.5	99	TC 2A13

*Included in Engine Weight.

**Serial nos. 7515001 and up

REPORT: VB-535 PAGE 5-12
MODEL: PA-28-151

ISSUED: MAY 14, 1973
REVISED: JUNE 14, 1974

Item	Item	Weight Lbs.	Arm Aft Datum	Moment	Cert. Basis
C. Landing Gear and Brakes					
	Two Main Wheel Assemblies	32.3	109.6	3540	TSO C26a
	(a) Cleveland Aircraft Products Wheel Assembly No. 40-86 Brake Assembly No. 30-55				
	(b) Two Main 4-Ply Rating Tires 6.00 - 6 with Regular Tubes				
	One Nose Wheel 5.00 - 5	8.3	29.8	247	TSO C26a
	(a) Cleveland Aircraft Products Wheel Assembly No. 40-77A (Less Brake Drum)				
	(b) One Nose Wheel 4-Ply Rating Tire 5.00 - 5 with Regular Tube				

CHEROKEE WARRIOR

Item	Item	Weight Lbs.	Arm Aft Datum	Moment	Cert. Basis
	D. Electrical Equipment				
_____	Stall Warning Device, Safe Flight Instrument Corporation No. 53514-101	.4	80.2	32	TSO C30b
_____	Voltage Regulator, Wico Electric *X-16300B	.5	51.9	26	TC 2A13
_____	Battery 12V, 25 A.H., Rebat Model S-25	21.9	114.9	2516	TC 2A13
_____	Overvoltage Relay, Wico Electric No. X16799	.5	55.4	28	TC 2A13
_____	Annunciator Lights *	.9	55.5	50	TC 2A13

| *Serial nos. 7515001 and up

REPORT: VB-535 PAGE 5-14
MODEL: PA-28-151

ISSUED: MAY 14, 1973
REVISED: JUNE 14, 1974

CHEROKEE WARRIOR

Item	Item	Weight Lbs.	Arm Aft Datum	Moment	Cert. Basis
E. Instrument					
_____	Compass - Piper Dwg. 67462	.9	59.9	54	TSO C7c
_____	Airspeed Indicator, Piper PS50049-16*	.6	61.8	37	TSO C2b
_____	Piper PS50049-25**	.6	61.8	37	TSO C2b
_____	Tachometer, Piper Dwg. 62177-3	.7	61.2	43	TC 2A13
_____	Altimeter, Piper PS50008-2 or -3	1.0	60.9	61	TSO C10b
_____	Engine Cluster, Piper Dwg. 95241-17	.8	62.4	50	TC 2A13
_____	Ammeter - Piper Dwg. 66696	.3	62.4	19	TC 2A13

*Serial nos. 7415001 through 7515449
 **Serial nos. 7615001 and up

ISSUED: MAY 14, 1973
 REVISED: JULY 14, 1975

REPORT: VB-535 PAGE 5-15
 MODEL: PA-28-151

CHEROKEE WARRIOR

Item	Item	Weight Lbs.	Arm Aft Datum	Moment	Cert. Basis
F. Miscellaneous					
_____	Forward Seat Belts (2) .75 lbs. each Piper Spec. PS50039-4-2A	1.5	81.9	123	TSO C22
_____	Inertia Safety Belts (2) 0.75 lbs. each Piper Spec. PS50039-4-17	1.5	119.6	179	TC 2A13
_____	Rear Seat Belts (2) .70 lbs. each Piper Spec. PS50039-4-3	1.4	123.0	172	TSO C22
_____	Rear Seat	20.0	124.2	2484	TC2A13
_____	Flight Manual	2.6	—	—	TC 2A13
_____	Toe Brakes (Dual) Piper Dwg. 63473	10.5	49.6	521	TC 2A13

CHEROKEE WARRIOR

Item	Item	Weight Lbs.	Arm Aft Datum	Moment	Cert. Basis
	G. Engine and Engine Accessories (Optional Equipment)				
_____	Vacuum Pump, Airborne Mfg. Co., Model No. 200cc and Drive	5.0	32.0	160	TC 2A13
_____	Oil Filter - Lycoming No.* 75528 (AC*OF5578770)	3.3	35.5	117	TC 2A13
_____	Oil Filter - Lycoming * *LW-13743 (Champion *CH-48110)	2.8	35.5	99	TC 2A13
_____	Vacuum Regulator *	.6	52.0	31	TC 2A13
_____	Vacuum Filter	.3	52.0	16	TC 2A13
_____	Primer System, Piper Dwg. 35327-0	1.2	50.0	60	TC 2A13
_____	Starter - Lycoming 76211 (Prestolite MZ4206) (Weight 18 lbs)	** 1.0	14.5	15	TC 2A13
_____	Vacuum Pump, Airborne Mfg. Co., Model 211cc and Drive, PAC 79399-0	3.2	32.0	103	TC 2A13
_____	Low Vacuum Annunciator Light ***	Neglect			TC 2A13
_____	Vacuum Regulator, Airborne Mfg. Co. * 2H3-19 ***	.5	52.0	26	TC 2A13

*Serial nos. 7415001 through 7415731

**Weight and moment difference between standard and optional equipment.

***Serial nos. 7515001 and up

ISSUED: MAY 14, 1973
REVISED: JUNE 14, 1974

REPORT: VB-535 PAGE 5-17
MODEL: PA-28-151

CHEROKEE WARRIOR

Item	Item	Weight Lbs.	Arm Aft Datum	Moment	Cert. Basis
H. Electrical Equipment (Optional Equipment)					
_____	Rotating Beacon	1.5	263.4	395	TC 2A13
_____	Landing Light, G.E. Model 4509	.5	13.1	7	TC 2A13
_____	Navigation Lights (2) Grimes Model A1285 (Red and Green)	.4	106.6	43	TSO C30b
_____	Navigation Light (Rear) (1) Grimes Model 2064 (White)	.2	281.0	56	TSO C30b
_____	Battery 12V, 35 A.H. Rebat R-35 (Weight 27.2 lbs.)	* 5.3	114.9	609	TC 2A13
_____	Cabin Light, Piper Dwgs. 66632-0 & 95229-0	.3	99.0	30	TC 2A13
_____	Cabin Speaker SB-15052 or 6EU 1937	.8	99.0	79	TC 2A13
_____	Auxiliary Power Receptacle, Piper Dwg. 35289	2.7	178.5	482	TC 2A13
_____	External Power Cable 62355-11	4.6	142.8	657	TC 2A13
_____	Piper Pitch Trim, Piper Dwg. 67496-2 or -3**	4.3	155.3	668	TC 2A13
_____	Heated Pitot Head Piper Dwg. 35493-2	.4	100.0	40	TC 2A13

*Weight and moment difference between standard and optional equipment.

**Serial nos. 28-7515213 and up.

REPORT: VB-535 PAGE 5-18
MODEL: PA-28-151

ISSUED: MAY 14, 1973
REVISED: JULY 14, 1975

CHEROKEE WARRIOR

Item	Item	Weight Lbs.	Arm Aft Datum	Moment	Cert. Basis
H. Electrical Equipment (Optional Equipment) (cont)					
_____	Red Strobe Light, Whelen Engineering Co. Piper Dwg. 99033-7				TSO C30b
_____	Power Supply, Whelen Model HS A412A-14	2.3	198.0	455	TC 2A13
_____	Light (Fin Tip)	.4	263.4	105	TC 2A13
_____	Cable	.4	230.7	92	TC 2A13
Red/White Strobe Light, Whelen Engineering Co. Piper Dwg. 99033-10					
_____	Power Supply, Whelen Model HD, T3 No. A413 (with Fin and Wing Lights)	3.0	198.0	594	TC 2A13
_____	Light (Fin Tip)	.4	263.4	105	TC 2A13
_____	Cable	.4	230.7	92	TC 2A13
_____	Lights (Wing Tip) (2)	.3	106.6	32	TC 2A13
_____	Cables	2.0	115.6	231	TC 2A13

ISSUED: MAY 14, 1973
 REVISED: JUNE 14, 1974

REPORT: VB-535 PAGE 5-19
 MODEL: PA-28-151

CHEROKEE WARRIOR

Item	Item	Weight Lbs.	Arm Aft Datum	Moment	Cert. Basis
I. Instruments (Optional Equipment)					
_____	Suction Gauge, Piper Dwg. 99480-0 or -2	.5	62.2	31	TC 2A13
_____	Vertical Speed, Piper Dwg. 99010-2, -4 or -5	1.0	60.9	61	TSO C8b
_____	Attitude Gyro, Piper Dwg. 99002-2, -3, -4 or -5	2.2	59.4	131	TSO C4c
_____	Directional Gyro, Piper Dwg. 99003-2, -3, -4 or -5	2.6	59.7	155	TSO C5c
_____	Air Temperature Gauge, Piper Dwg. 99479-0 or -2	.2	72.6	15	TC 2A13
_____	Clock	.4	62.4	25	TC 2A13
_____	Tru-Speed Indicator, Piper PS50049-15**		(Same as Standard Equipment)		TC 2A13
_____	Piper PS50049-26***		(Same as Standard Equipment)		TC 2A13
_____	Turn and Slip Indicator, Piper PS50030-2 or -3	2.6	59.7	155	TSO C3b
_____	Encoding Altimeter Piper PS50008-6 or -7	* .9	60.3	54	TSO C10b C88
_____	Engine Hour Meter*** Piper Dwg. 79548-2	.3	61.2	18	TC 2A13

*Weight and moment difference between standard and optional equipment.

**Serial nos. 7415001 through 7515449.

***Serial nos. 7615001 and up.

CHEROKEE WARRIOR

Item	Item	Weight Lbs.	Arm Aft Datum	Moment	Cert. Basis
J. Autopilots (Optional Equipment)					
AutoControl III, Piper *					
Dwg. 79221-7,-8, -9					
_____	Roll Servo, *1C363-1-430R	2.5	122.2	306	STC SA1406SW
_____	Console, *1C338 (thru S/N 9999)	1.2	60.1	72	STC SA1406SW
_____	Cables	.7	95.5	67	STC SA1406SW
_____	Attitude Gyro, * 52D66	2.3	59.4	137	STC SA1406SW
_____	Directional Gyro, * 52D54	3.2	59.0	189	STC SA1406SW
_____	Omni Coupler, *1C388	.9	59.3	53	STC SA1406SW
AutoFlite II, Piper Dwg. 99447-3					
_____	Roll Servo, * 1C363-1-430R	2.5	122.2	306	***
_____	Cable	.7	93.4	65	***
_____	Panel Unit, * 52D75-3 or -4	2.4	59.4	143	***
AutoControl III B **					
_____	Roll Servo *1C363-1-430R	2.5	122.2	306	****
_____	Console, *1C338 (S/N 10000 & up)	1.0	60.1	60	****
_____	Cables	.5	95.5	48	****
_____	Attitude Gyro, *52D66	2.7	59.4	160	****
_____	Directional Gyro, * 52D54	2.9	59.0	171	****
_____	Omni Coupler, *1C388	1.0	59.3	59	****

*Serial nos. 7415001 through 7415731

**Serial nos. 7515001 and up

***STC SA1406SW for serial nos. 7415001 through 7515449. STC SA3066SW-D for serial nos. 7615001 and up.

****STC SA1406SW for serial nos. 7515001 through 7515449. STC SA3065SW-D for serial nos. 7615001 and up.

ISSUED: MAY 14, 1973
REVISED: JULY 14, 1975

REPORT: VB-535 PAGE 5-21
MODEL: PA-28-151

CHEROKEE WARRIOR

Item	Item	Weight Lbs.	Arm Aft Datum	Moment	Cert. Basis
K. Radio Equipment (Optional Equipment)					
_____	Narco Mark 16 (VHF Comm/Nav) * Transceiver, Single	7.5	56.9	427	TC 2A13
_____	Transceiver, Dual	15.0	56.9	854	TC 2A13
_____	Narco VOA-50M Omni Converter *	2.1	59.9	126	TC 2A13
_____	Narco VOA-40 (M) Omni Converter *	1.9	59.9	114	TC 2A13
_____	Narco VOA-40 Omni Converter *	1.9	59.9	114	TC 2A13
_____	Narco Comm 10A VHF Transceiver	3.9	57.4	224	TC 2A13
_____	Narco Comm 11A VHF Transceiver	3.6	57.4	207	TC 2A13
_____	Narco Dual Comm 11A VHF Transceiver	7.1	57.4	408	TC 2A13
_____	Narco Nav 10 VHF Receiver	1.9	58.6	111	TC 2A13
_____	Narco Nav 11 VHF Receiver	2.8	58.6	164	TC 2A13
_____	Narco Nav 12 VHF Receiver	3.4	58.6	199	TC 2A13
_____	Narco Dual Nav 11 VHF Receiver	5.6	58.6	328	TC 2A13
_____	King KX-175B() VHF Transceiver	9.4	56.6	532	TC 2A13
_____	King KN-73 Glide Slope Receiver	3.2	184.3	590	TC 2A13
_____	King KN-77 VOR/LOC Converter	3.6	183.6	661	TC 2A13
_____	King KNI-520 VOR/ILS Indicator	1.7	60.5	103	TC 2A13
_____	King KX-175B() VHF Transceiver (2nd)	8.6	56.6	487	TC 2A13
_____	King KN-77 VOR/LOC Converter	4.2	183.6	771	TC 2A13
_____	King KNI-520 VOR/ILS Indicator	1.7	60.5	103	TC 2A13

*Serial nos. 7415001 through 7415731

REPORT: VB-535 PAGE 5-22
MODEL: PA-28-151

ISSUED: MAY 14, 1973
REVISED: JUNE 14, 1974

CHEROKEE WARRIOR

Item	Item	Weight Lbs.	Arm Aft Datum	Moment	Cert. Basis
K. Radio Equipment (Optional Equipment) (cont)					
_____	Narco Comm 110 VHF Transceiver *	3.0	57.4	172	TC 2A13
_____	Narco Comm 111 Transceiver	3.0	57.4	172	TC 2A13
_____	Narco Dual Comm 111 Transceiver	6.0	57.4	344	TC 2A13
_____	Narco Nav 110 VHF Receiver *	1.7	58.6	100	TC 2A13
_____	Narco Nav 111 VHF Receiver	2.5	58.6	147	TC 2A13
_____	Narco Nav 112 VHF Receiver	3.3	58.6	193	TC 2A13
_____	King KX170B () (VHF Comm/Nav) Transceiver, Single	7.5	56.6	425	TC 2A13
_____	Transceiver, Dual	15.0	56.6	849	TC 2A13
_____	King KI201 () VOR/LOC Ind.	2.5	59.6	149	TC 2A13
_____	King Dual KI201 () VOR/LOC Ind.	5.0	59.9	300	TC 2A13
_____	King KI214 () VOR/LOC/GS Ind.	3.3	59.9	198	TC 2A13
_____	Nav Receiving Antenna	.5	265.0	133	TC 2A13
_____	Cable, Nav Antenna	.9	157.0	141	TC 2A13
_____	*1 VHF Comm Antenna	.3	157.8	47	TC 2A13
_____	Cable, Antenna *1 VHF	.4	103.4	41	TC 2A13
_____	*2 VHF Comm Antenna	.3	192.8	58	TC 2A13
_____	Cable, Antenna *2 VHF	.5	120.9	60	TC 2A13

*Serial nos. 7415001 through 7415731

ISSUED: MAY 14, 1973
 REVISED: JUNE 14, 1974

REPORT: VB-535 PAGE 5-23
 MODEL: PA-28-151

CHEROKEE WARRIOR

Item	Item	Weight Lbs.	Arm Aft Datum	Moment	Cert. Basis
K. Radio Equipment (Optional Equipment) (cont)					
Anti Static Kit					
_____	*1 VHF Comm Antenna	1.0	160.8	161	TC 2A13
_____	Cable *1 VHF Antenna	0.4	103.4	41	TC 2A13
_____	*2 VHF Comm Antenna	1.0	195.8	196	TC 2A13
_____	Cable *2 VHF Comm Antenna	0.5	120.9	60	TC 2A13
_____	Low Frequency Antenna	0.5	147.5	74	TC 2A13
_____	Static Wicks	—	—	—	TC 2A13
Narco ADF-31 A/B *					
_____	Panel Unit	5.0	58.5	293	TC 2A13
_____	Sensor Unit	2.5	162.7	407	TC 2A13
_____	Sensor Cable	2.3	100.6	231	TC 2A13
_____	Sense Antenna and Cable	.4	150.0	60	TC 2A13
Bendix ADF-T-12C* or Bendix ADF-T-12D*					
_____	Receiver	3.5	59.4	208	TC 2A13
_____	Audio Amplifier	.8	52.4	42	TC 2A13
_____	Servo Indicator	1.7	60.9	104	TC 2A13
_____	Loop Antenna	1.3	160.8	209	TC 2A13
_____	Cable, Interconnecting	2.3	108.0	248	TC 2A13
_____	Sense Antenna and Cable	.4	150.0	60	TC 2A13
King KR-85					
_____	Receiver	4.3	59.4	255	TC 2A13
_____	Servo Indicator	1.2	61.3	74	TC 2A13
_____	Loop Antenna	1.3	161.5	210	TC 2A13
_____	Loop Cable	1.8	108.0	194	TC 2A13
_____	Audio Amplifier	.8	51.0	41	TC 2A13
_____	Sense Antenna and Cable	.4	150.0	60	TC 2A13
PM-1 Marker Beacon *					
_____	Receiver	1.1	121.3	133	TC 2A13
_____	Remote Unit	.3	128.4	39	TC 2A13
_____	Cable	.3	80.0	24	TC 2A13
UGR-2A Glide Slope					
_____	Receiver	2.4	173.8	417	TC 2A13
_____	Cable	1.8	128.0	230	TC 2A13
_____	Antenna	.4	87.4	35	TC 2A13
_____	Cable, Antenna	.5	145.0	73	TC 2A13

*Serial nos. 7415001 through 7415731

REPORT: VB-535 PAGE 5-24
MODEL: PA-28-151

ISSUED: MAY 14, 1973
REVISED: JUNE 14, 1974

CHEROKEE WARRIOR

Item	Item	Weight Lbs.	Arm Aft Datum	Moment	Cert. Basis
K.	Radio Equipment (Optional Equipment) (cont)				
_____	Narco CP-25B/125 Audio Selector Panel *	1.5	60.2	90	TC 2A13
_____	Narco MBT-12-R Marker Beacon	3.1	69.1	214	TC 2A13
_____	Narco AT50A Transponder Panel Unit	** 3.0	57.3	172	TC 2A13
_____	King KT76/78 Transponder Panel Unit	3.1	58.1	180	TC 2A13
_____	Antenna and Cable	—	—	—	TC 2A13
_____	King KMA-20 () Audio Panel	2.8	60.2	169	TC 2A13
_____	Antenna	.5	116.3	58	TC 2A13
_____	Cable	.4	87.5	35	TC 2A13
_____	King KN60C DME Receiver	6.8	56.7	386	TC 2A13
_____	Antenna	.2	107.1	21	TC 2A13
_____	Cable, Antenna	0.3	80.6	24	TC 2A13
	Piper Automatic Locator, Piper Dwg. 99890				
_____	Transmitter, Piper Dwg. 79265-0	1.7	236.2	402	TC 2A13
_____	Transmitter, Piper Dwg. 79265-6	1.3	236.2	307	TC 2A13
_____	Transmitter, Piper Dwg. 79265-4	1.7	236.2	454	TC 2A13
_____	Antenna and Cable	.2	224.4	45	TC 2A13
_____	Shelf and Access Plate	.3	235.4	71	TC 2A13
_____	Audio Selector Panel,* Piper Dwg. 99395-0, -2 or -3	.7	61.3	43	TC 2A13
_____	Microphone (Dynamic) Piper Dwg. 68856-12	.5	70.0	35	TC 2A13
_____	Microphone (Carbon), Piper Dwg. 68856-10	.5	70.0	35	TC 2A13

*Serial nos. 7415001 through 7415731
 **Weight includes Antenna and Cable.

ISSUED: MAY 14, 1973
 REVISED: JULY 20, 1976

REPORT: VB-535 PAGE 5-25
 MODEL: PA-28-151

CHEROKEE WARRIOR

Item	Item	Weight Lbs.	Arm Aft Datum	Moment	Cert. Basis
K. Radio Equipment (Optional Equipment) (cont)					
_____	Headset, Piper Dwg. 68856-10	.5	60.0	30	TC 2A13
_____	King KI-213 VOR/LOC/GS Indicator*	2.5	60.4	151	TC 2A13
King KR-86 ADF *					
_____	Receiver	3.9	59.4	232	TC 2A13
_____	Loop Antenna	1.5	161.5	242	TC 2A13
_____	Loop Cable	1.3	108.0	140	TC 2A13
_____	Audio Amplifier	0.8	51.0	41	TC 2A13
_____	Sense Antenna & Cable	0.4	150.0	60	TC 2A13
King KR-86 ADF (2nd) *					
_____	Receiver	3.9	59.4	232	TC 2A13
_____	Loop Antenna	1.5	150.7	226	TC 2A13
_____	Loop Cable	1.3	105.0	137	TC 2A13
_____	Sense Antenna & Cable	3.0	147.5	443	TC 2A13
King KN-65 DME *					
_____	Receiver	7.6	201.6	1532	TC 2A13
_____	Antenna	0.2	107.1	21	TC 2A13
_____	Cable, Antenna	0.3	157.1	47	TC 2A13
_____	Indicator	1.0	62.4	62	TC 2A13
King KN-74 R-Nav *					
_____	Computer	3.7	57.6	213	TC 2A13
_____	Cable Assy.	1.0	53.0	53	TC 2A13
_____	Narco Comm 11B VHF Transceiver *	3.9	57.4	224	TC 2A13
_____	Narco Dual Comm 11B VHF Transceiver *	7.8	57.4	448	TC 2A13
_____	Narco Comm 111B VHF Transceiver *	3.9	57.4	224	TC 2A13
_____	Narco Dual Comm 111B VHF Transceiver *	7.8	57.4	448	TC 2A13
_____	King KN61 DME	12.5	179.0	2237	TC 2A13
_____	King KN65A DME	13.0	174.9	2274	TSO C66a

*Serial nos. 7515001 and up

CHEROKEE WARRIOR

Item	Item	Weight Lbs.	Arm Aft Datum	Moment	Cert. Basis
	K. Radio Equipment (Optional Equipment) (cont)				
_____	Narco Nav 14 VHF Receiver *	2.5	57.4	144	TC 2A13
_____	Narco Nav 114 VHF Receiver *	2.5	57.4	144	TC 2A13
	Narco UGR-3 Glide Slope *				
_____	Receiver	2.4	173.8	417	TC 2A13
_____	Cable	1.8	128.0	230	TC 2A13
_____	Antenna	0.4	87.4	35	TC 2A13
_____	Cable, Antenna	0.5	145.0	73	TC 2A13
_____	Narco CP-125 Audio Selector Panel *	2.2	60.2	132	TC 2A13
	Narco ADF-140 *				
_____	Receiver	2.5	58.3	146	TC 2A13
_____	Servo Indicator	1.3	61.0	79	TC 2A13
_____	Loop Antenna	1.6	162.0	259	TC 2A13
_____	Cable, Loop	0.6	105.5	63	TC 2A13
_____	Sense Antenna and Cable	0.4	147.5	59	TC 2A13
	Narco Dual ADF-140 *				
_____	Receivers	5.0	58.3	292	TC 2A13
_____	Dual Needle Indicator	3.5	61.0	214	TC 2A13
_____	Loop Antenna * 1	1.6	162.0	259	TC 2A13
_____	Cable, Loop * 1	0.6	105.5	63	TC 2A13
_____	Sense Antenna and Cable * 1	0.4	143.8	58	TC 2A13
_____	Loop Antenna * 2	1.6	150.0	240	TC 2A13
_____	Cable, Loop * 2	0.6	93.5	56	TC 2A13
_____	Sense Antenna and Cable * 2	3.0	143.8	431	TC 2A13
_____	Remote for Dual Ind.	2.0	185.5	371	TC 2A13
	Narco DME-190 *				
_____	Receiver	5.2	56.8	295	TC 2A13
_____	Antenna	0.3	108.9	33	TC 2A13
_____	Cable, Antenna	0.4	80.6	32	TC 2A13
_____	* Microphone (Dynamic)* Piper Dwg. 68856-11	0.6	69.9	42	TC 2A13

*Serial nos. 7515001 and up

ISSUED: JUNE 14, 1974

REPORT: VB-535 PAGE 5-25b
MODEL: PA-28-151

CHEROKEE WARRIOR

Item	Item	Weight Lbs.	Arm Aft Datum	Moment	Cert. Basis
L. Miscellaneous (Optional Equipment)					
_____	Fire Extinguisher, Scott Aviation 42211-00, Piper Dwg. 76167-2	4.6	71.0	327	TC 2A13
_____	Assist Step Piper Dwg. 65384-0	1.8	156.0	281	TC 2A13
_____	Inertia Safety Belts (Rear) (2) 0.8 lbs. each Piper Spec. PS50039-4-14	1.6	140.3	224	TC 2A13
_____	Tow Bar, Piper Dwg. 99458	1.3	140.0	182	TC 2A13
_____	Nose Wheel Fairing Piper Dwg. 35513	3.8	29.8	113	TC 2A13
_____	Main Wheel Fairings Piper Dwg. 65237	7.6	113.6	863	TC 2A13
_____	Vert. Adj. Front Seats (Left) Piper Dwg. 76340-0	* 6.6	80.7	533	TC 2A13
_____	(Left) Piper Dwg. 79591-0	* 6.6	80.3	530	TC 2A13
_____	Vert. Adj. Front Seat (Right) Piper Dwg. 76340-1	* 6.8	80.0	544	TC 2A13
_____	(Right) Piper Dwg. 79591-1	* 6.6	79.6	525	TC 2A13
_____	Super Cabin Sound Proofing Piper Dwg. 79030-2	18.1	86.8	1571	TC 2A13
_____	Rear Seat Vents	2.5	98	245	TC 2A13
_____	Lighter, 12V Universal 200462	.2	62.9	13	TC 2A13
_____	Assist Strap and Coat Hook, Piper Dwg. 62353-5	.2	109.5	22	TC 2A13
_____	Assist Strap Piper Dwg. 79455	.2	109.5	22	TC 2A13

*Weight and moment difference between standard and optional equipment.

CHEROKEE WARRIOR

Item	Item	Weight Lbs.	Arm Aft Datum	Moment	Cert. Basis
L. Miscellaneous (Optional Equipment) (cont)					
_____	Overhead Vent System with Ground Ventilating Blower, Piper Dwg. 76304-2	12.9	170.1	2194	TC 2A13
_____	Overhead Vent System, Piper Dwg. 76304-0	5.3	155.8	822	TC 2A13
_____	Overhead Vent System, Piper Dwg. 76304-9	6.4	159.6	1022	TC 2A13
_____	Overhead Vent System with Ground Ventilating Blower, Piper Dwg. 76304-10	14.0	170.7	2390	TC 2A13
_____	Alternate Static Source, Piper Dwg. 67479-2	.4	61.0	24	TC 2A13
Calibrated Alternate Static Source					
Placard Required: Yes _____ No _____					
_____	Headrest (2) (Front)	2.2	94.5	208	TC 2A13
_____	Sun Visors, Piper Dwg. 66991-0	1.5	85.0	128	TC 2A13
_____	Zinc Chromate Finish, Piper Dwg. 65665	5.0	158.0	790	TC 2A13
_____	Corrosive Resistant Kit	3.0	106.0	318	TC 2A13
_____	Stainless Steel Control Cables	—	—	—	TC 2A13
TOTAL OPTIONAL EQUIPMENT		_____	_____	_____	

ISSUED: MAY 14, 1973
REVISED: JULY 14, 1975

REPORT: VB-535 PAGE 5-27
MODEL: PA-28-151

CHEROKEE WARRIOR

EXTERIOR FINISH

Base Color _____

Registration No. Color _____

Trim Color _____

Type Finish _____

Accent Color _____

LOADING INSTRUCTIONS

**THIS SECTION IS NOT
APPLICABLE TO THIS AIRPLANE**

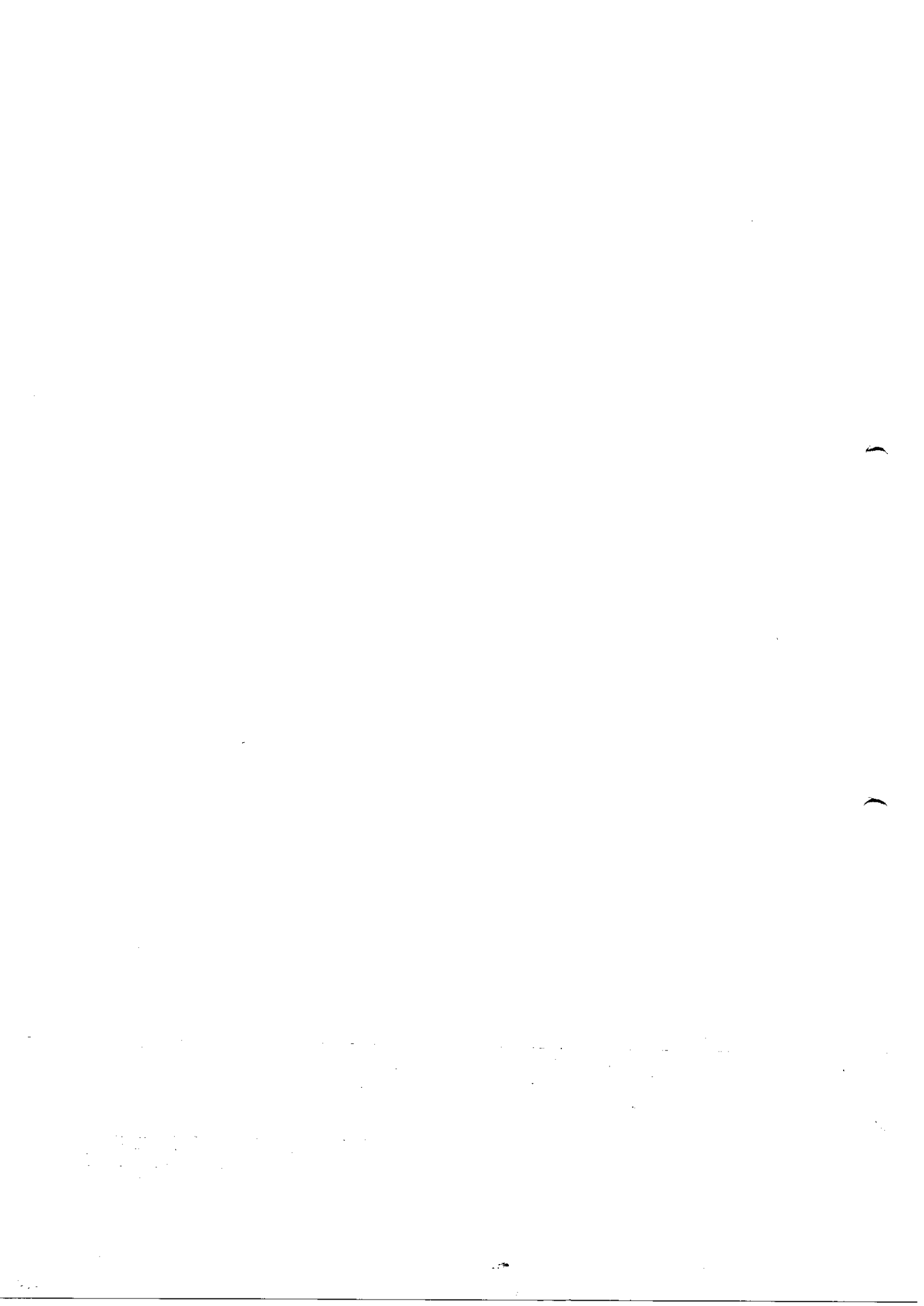

OPERATING INSTRUCTIONS

Preflight	7-1
Walk-Around Inspection	7-1
Starting Engine	7-2
Starting Engine When Cold	7-3
Starting Engine When Hot	7-3
Starting Engine When Flooded	7-3
Starting Engine with External Power Source	7-3
Warm-Up	7-4
Ground Check	7-4
Takeoff	7-5
Climb	7-6
Stalls	7-6
Cruising	7-6
Turbulent Air Operation	7-7
Maneuvers	7-7
Engine Power Loss	7-8
Approach and Landing	7-8
Stopping Engine	7-9
Airspeed Data	7-9
Mooring	7-9
Weight and Balance	7-9
Emergency Locator Transmitter	7-10

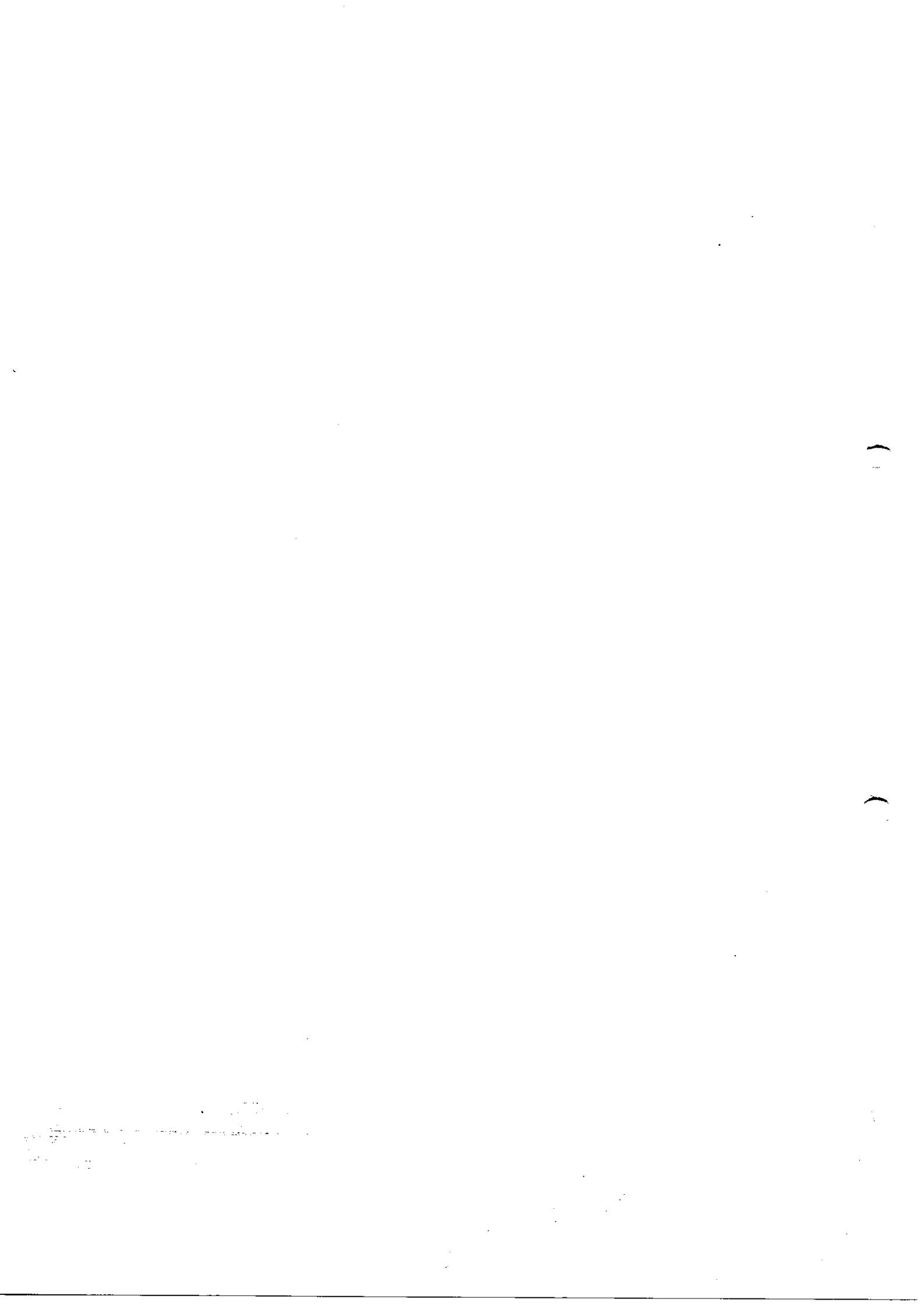

OPERATING INSTRUCTIONS

PREFLIGHT

The airplane should be given a thorough preflight and walk-around inspection. The preflight should include a check of the airplane's operational status and computation of weight and C.G. limits, takeoff distance, and in flight performance. A weather briefing should be obtained for the intended flight path, and any other factors relating to a safe flight should be checked before takeoff.

WALK-AROUND INSPECTION

1. In Cabin
 - a. Release seat belt securing controls.
 - b. Master switch ON.
 - c. Check fuel quantity gauges.
 - d. Master switch OFF.

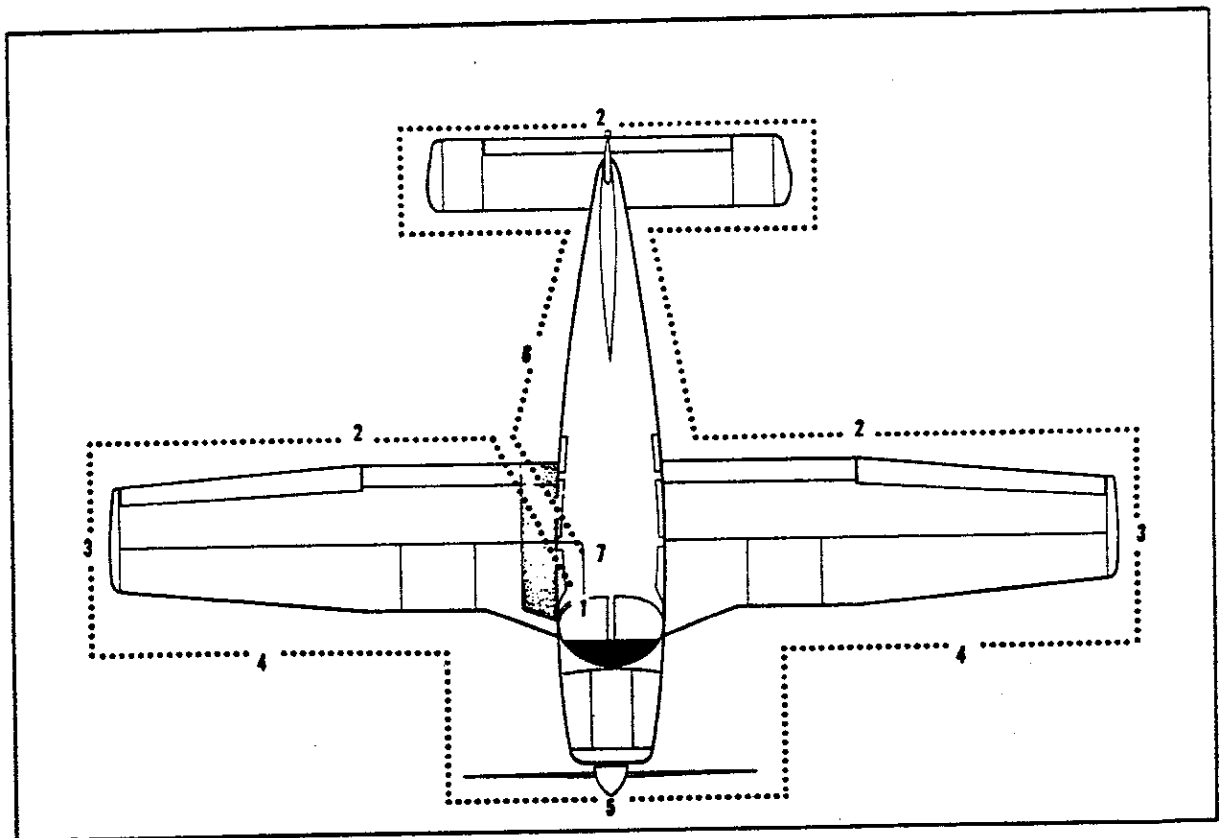

CHEROKEE WARRIOR

2. Control Surfaces
 - a. Check for external damage and operational interference of control surfaces or hinges.
 - b. Insure that wings and control surfaces are free of snow, ice, or frost.
3. Wings
 - a. Visually check fuel supply; secure caps.
 - b. Drain fuel sumps (two on each wing for early models, one on each wing for later models).
 - c. Check that fuel system vents are open.
 - d. On left wing check that pitot head cover is removed and that holes in the pitot-static head are unobstructed.
4. Main Landing Gear
 - a. Check main gear shock struts for proper inflation (approximately 4.50 inches showing).
 - b. Check tires for cuts, wear and proper inflation.
 - c. Check brake blocks and discs for wear and damage.
5. Nose Section
 - a. Inspect windshield for cleanliness.
 - b. Check the propeller and spinner for defects, dirt and cracks.
 - c. Check for obvious fuel and oil leaks.
 - d. Drain gascolator fuel sump (left side of airplane).
 - e. Check oil level, 8 quarts maximum. (Insure that the dipstick is properly seated.)
 - f. Check cowling and inspection covers for security.
 - g. Check nose wheel tire for damage, wear, and proper inflation.
 - h. Check nose gear shock strut for proper inflation (approximately 3.25 inches showing).
 - i. Check for foreign matter in air inlets.
6. Fuselage
 - a. Stow tow bar if used.
 - b. Check baggage for proper storage and security.
 - c. Close and secure the baggage compartment door.
7. Inside Airplane
 - a. Upon entering the airplane, ascertain that all flight controls operate properly.
 - b. Close and secure the cabin door.
 - c. Check that required papers are in the airplane.
 - d. Fasten seat belts and shoulder harnesses. Check function of inertia reels.

STARTING ENGINE

1. Set parking brake ON.
2. Set the carburetor heat control in the full OFF position.
3. Select the desired tank with the fuel selector valve.

STARTING ENGINE WHEN COLD

1. Open throttle approximately 1/4 inch.
2. Turn the master switch ON.
3. Turn the electric fuel pump ON.
4. Move the mixture control to FULL RICH.
5. Engage the starter by rotating the magneto switch clockwise and pressing in.
6. When the engine fires, advance the throttle to the desired setting. If the engine does not fire within five to ten seconds, disengage the starter and prime with one to three strokes of the priming pump if one is installed. Repeat the starting procedure.

STARTING ENGINE WHEN HOT

1. Open the throttle approximately 1/2 inch.
2. Turn the master switch ON.
3. Turn the electric fuel pump ON.
4. Put the mixture control in full RICH.
5. Engage the starter by rotating the magneto switch clockwise and pressing in. When the engine fires, move the throttle to the desired setting.

STARTING ENGINE WHEN FLOODED

1. Open the throttle FULL.
2. Turn the master switch ON.
3. Turn the electric fuel pump OFF.
4. Put the mixture control in IDLE CUT-OFF.
5. Engage the starter by rotating the magneto switch clockwise and pressing in. When the engine fires, advance the mixture control and retard the throttle to the desired setting.

When the engine is firing evenly, advance the throttle to 800 RPM. If oil pressure is not indicated within 30 seconds, stop the engine and determine the trouble. In cold weather, it will take a few seconds longer to get an oil pressure indication. If the engine has failed to start, refer to the "Lycoming Operating Handbook" for the appropriate engine model.

Starter manufacturers recommend that cranking periods be limited to thirty seconds with a two minute rest between cranking periods. Longer cranking will shorten the life of the starter.

STARTING ENGINE WITH EXTERNAL POWER SOURCE*

An optional feature called Piper External Power (PEP) allows the operator to use an external battery to crank the engine without having to gain access to the airplane battery.

The procedure is as follows:

1. Turn the airplane master switch OFF.

*Optional equipment

OPERATING INSTRUCTIONS
ISSUED: JULY 17, 1973
REVISED: NOVEMBER 7, 1988

CHEROKEE WARRIOR

2. Connect the RED lead of the PEP kit jumper cable to the POSITIVE (+) terminal of an external 12-volt battery and the BLACK lead to the NEGATIVE (-) terminal.
3. Insert the plug of the jumper cable into the socket located on the airplane's fuselage.
4. Turn the airplane master switch ON and proceed with the normal engine starting technique.
5. After the engine has been started, turn the master switch OFF and disconnect the jumper cable plug from the airplane.
6. Turn the master switch ON and check the alternator ammeter for indication of output. DO NOT ATTEMPT FLIGHT IF THERE IS NO INDICATION OF ALTERNATOR OUTPUT.

WARM-UP

Warm-up the engine at 800 to 1200 RPM for not more than two minutes in warm weather or four minutes in cold weather. Avoid prolonged idling at low RPM as this practice may result in fouled spark plugs. If necessary to hold before takeoff, it is recommended that the engine be idled at 1200 RPM.

Takeoff may be made as soon as the ground check is completed, provided the throttle may be opened fully without backfiring or skipping and without a reduction in engine oil pressure.

GROUND CHECK

Check the magnetos at 2000 RPM by switching from BOTH to RIGHT, then back to BOTH before switching to LEFT. The drop on either magneto should not exceed 175 RPM, and each magneto should read within 50 RPM of the other. Prolonged operation on one magneto should be avoided.

Check the vacuum gauge; the indicator should read $5'' \pm .1''$ Hg at 2000 RPM.

Check both the oil temperature and pressure. The temperature may be low for some time if the engine is being run for the first time of the day, but as long as the oil pressure is within limits, the engine is ready for takeoff.

Check the annunciator panel lights with the press-to-test button*.

Carburetor heat should also be checked prior to takeoff to be sure that the control is operating properly and to clear any ice that may have formed during taxiing. Avoid prolonged operation with carburetor heat ON as the air is unfiltered. Be sure that carburetor heat is OFF for takeoff.

Operation of the engine driven fuel pump should be checked while taxiing or during preflight engine runup by switching the electric fuel pump OFF and observing the fuel pressure gauge. The electric fuel pump should be ON during takeoff to prevent loss of power during takeoff should the engine driven pump fail. The engine is warm enough for takeoff when the throttle can be fully opened without the engine faltering.

*Serial nos. 7515001 and up

TAKEOFF

Just before takeoff the following items should be checked:

1. Fuel - on proper tank
2. Electric fuel pump - on
3. Engine gauges - checked
4. Flaps - set
5. Carburetor heat - off
6. Mixture - set
7. Seat backs - erect
8. Safety belts/harness - fastened
9. Trim tab - set
10. Controls - free
11. Door - latched

NOTE

Mixture full rich except a minimum amount of leaning is permitted for smooth engine operation when taking off at high elevation.

The takeoff technique is conventional. The trim tab should be set slightly aft of neutral with the exact setting determined by the loading of the airplane. Allow the airplane to accelerate to 50 to 60 miles per hour, then ease back on the wheel enough to let the airplane fly itself from the ground. Premature raising of the nose or raising it to an excessive angle will result in a delayed takeoff. After takeoff, let the airplane accelerate to the desired climb speed by lowering the nose slightly.

Takeoffs are normally made with flaps up; however, for short field takeoffs and for takeoffs under difficult conditions such as deep grass or a soft surface, distances can be reduced appreciably by lowering the flaps to 25° and rotating at lower airspeeds.

Short Field, Obstacle Clearance:

Lower the flaps to 25°. Apply full power before brake release. Accelerate to 66 MPH CAS and rotate, maintaining 66 MPH CAS until obstacle clearance has been attained. After the obstacle has been cleared accelerate to 87 miles per hour and then slowly retract the flaps.

Short Field, No Obstacle:

Use of partial flaps does not decrease minimum ground roll, therefore, leave the flaps up or lower the flaps to 25° as desired. Apply full power before brake release. Accelerate to 65 MPH CAS with flaps up or 52 MPH CAS with flaps at 25° and rotate. After breaking ground, accelerate to best rate of climb speed of 87 MPH CAS. Slowly retract the flaps while climbing out.

Soft Field, Obstacle Clearance:

Lower the flaps to 25°. Accelerate airplane, lift nose gear off as soon as possible, and lift off at lowest possible airspeed. Accelerate just above the ground to 66 MPH CAS to climb past obstacle clearance height. Continue climbing while accelerating to the best rate of climb speed, 87 miles per hour, and slowly retract the flaps.

Soft Field, No Obstacle:

Lower the flaps to 25°. Accelerate the airplane and lift the nose gear off as soon as possible, then lift off at the lowest possible airspeed. Accelerate just above the ground to the best rate of climb speed, 87 miles per hour. Climb out while slowly retracting the flaps.

CHEROKEE WARRIOR

CLIMB

The best rate of climb at gross weight will be obtained at 87 miles per hour. The best angle of climb is at 76 miles per hour. At lighter than gross weight, these speeds are somewhat reduced. For climbing en route, a speed of 100 miles per hour is recommended. This will produce better forward speed and increased visibility over the nose during the climb. Shallow turns of a few degrees will also aid forward visibility during climb out.

STALLS

Stall characteristics are conventional. Audible stall warning is provided by a horn located behind the instrument panel which sounds automatically at between 5 and 10 miles per hour above stall speed.

Stall speed at a gross weight of 2325 pounds with power off and full flaps is 58 miles per hour. With flaps up, this speed is increased.

The stall speed chart is at gross weight. Stall speeds at lower weights will be correspondingly less.

STALL SPEED TABLE

Angle of Bank	Flaps 40°	Flaps Retracted
0°	58 MPH	64.5 MPH
20°	60 MPH	67 MPH
40°	66 MPH	74 MPH
50°	72 MPH	80 MPH
60°	82 MPH	91 MPH

Power Off – Gross Weight 2325 Lbs.

CRUISING

The cruising speed is determined by many factors, including power setting, attitude, temperature, loading, and equipment installed on the airplane.

The normal cruising power is 75% of the rated horsepower of the engine. True airspeeds, which may be obtained at various altitudes and power settings, can be determined from the charts in the Performance Charts Section of this manual.

Use of the mixture control in cruising flight reduces fuel consumption significantly, especially at higher altitudes, and reduces lead deposits when the alternate fuels are used.

The mixture should be leaned when 75% power or less is being used. If any doubt exists as to the amount of power being used, the mixture should be in the FULL RICH position for all operations. Always enrich the mixture before increasing power settings.

To lean the mixture, pull the mixture control until the engine becomes rough, indicating that the lean mixture limit has been reached in the leaner cylinders. Then enrich the mixture by pushing the control toward the instrument panel until engine operation becomes smooth.

The continuous use of carburetor heat during cruising flight decreases engine efficiency. Unless icing conditions in the carburetor are severe, do not cruise with carburetor heat on. Apply FULL carburetor heat slowly and only for a few seconds at intervals determined by the icing conditions.

In order to keep the airplane in best lateral trim during cruise flight, the fuel should be used alternately from each tank. It is recommended that one tank be used for one hour after takeoff, the other tank be used for two hours, then return to the first tank. The second tank will contain approximately one half hour of fuel. Do not run tanks completely dry in flight.

The following is a list of some fuel management recommendations:

1. Fuel quantity should be visually checked in both tanks before entering the airplane.
2. Takeoff should be made on the fuller tank to assure best fuel flow, and this tank selected before or immediately after starting to establish an adequate fuel flow before takeoff. The tank with the higher fuel quantity should be selected for landing.
3. Fuel tank selection at low altitude is not recommended since adequate recovery time is essential in the event of an error in fuel selection.
4. The electric fuel pump should be turned on before switching tanks and left on for a short period thereafter.
5. To avoid the necessity of making a hasty selection and to assure a continuous fuel flow, the selector should be changed to another tank before the fuel is exhausted from the tank in use.
6. Operation of the engine driven pump should be checked while taxiing or during the preflight runup by switching off the electric fuel pump and observing the fuel pressure.
7. During cruise, the electric fuel pump should be in the off position so that any malfunction of the engine driven fuel pump is immediately apparent.
8. If signs of fuel starvation should occur at any time during flight, fuel exhaustion should be suspected, at which time the fuel selector should immediately be positioned to the fuller tank and the electric fuel pump switched to the on position.

TURBULENT AIR OPERATION

In keeping with good operating practice used in all aircraft, it is recommended that when turbulent air is encountered or expected, the airspeed be reduced to maneuvering speed to reduce the structural load caused by gusts and to allow for inadvertent speed build-ups which may occur as a result of the turbulence or distractions caused by the conditions.

MANEUVERS

The airplane must be operated as a normal or utility category airplane in compliance with the operating limitations stated in the form of placards and markings, and those given in the Airplane Flight Manual. Except for training maneuvers (steep turns, chandelles, and lazy eights) which are permitted only when the airplane is loaded to the utility category, acrobatic maneuvers are prohibited.

CHEROKEE WARRIOR

Intentional spins are prohibited. Maneuvering at speeds in excess of 124 mph must be avoided in order to prevent overstressing the airframe.

ENGINE POWER LOSS

The most common cause of engine power loss is mismanagement of fuel. Therefore, the first step to take after engine power loss is to move the fuel selector to the tank not being used. This will often restore power even if there is no apparent reason for the engine to stop on the tank being used.

If changing to another tank does not restore power:

1. Check fuel pressure - if electric fuel pump is off, turn it ON.
2. Push mixture control to full RICH.
3. Check ignition switch. Turn to best operating magneto - LEFT, RIGHT, or BOTH.

APPROACH AND LANDING

Before landing check list:

1. Seat backs - erect
2. Safety belts/harness - fastened
3. Fuel - on proper tank
4. Electric fuel pump - on
5. Mixture - full rich
6. Flaps - set (115 MPH)*

The airplane should be trimmed to an approach speed of about 80 MPH with flaps up. The flaps can be lowered at speeds up to 115 MPH*, if desired, and the approach speed reduced 3 MPH for each additional notch of flaps. Carburetor heat should not be applied unless there is an indication of carburetor icing, since the use of carburetor heat causes a reduction of power which could be critical should a go-around be necessary. Full throttle operation with carburetor heat on is likely to cause detonation.

The amount of flap used during landings and the speed of the airplane at contact with the runway should be varied according to the landing surface, wind conditions, and airplane loading. It is generally good practice to contact the ground at the minimum possible safe speed consistent with existing conditions.

Normally, the best technique for short and slow landings is to use full flap and enough power to maintain the desired airspeed and approach flight path. Reduce the airspeed during flareout and contact the ground at close to stalling speed. After ground contact hold the nose wheel off as long as possible. As the airplane slows down, drop the nose and apply the brakes. There will be less chance of skidding the tires if the flaps are retracted before applying the brakes. Braking is most effective when back pressure is applied to the control wheel, putting most of the airplane weight on the main wheels. In high wind conditions, particularly in strong crosswinds, it may be desirable to approach the ground at higher than normal speeds with partial or no flaps.

*125 MPH on serial nos. 7415001 through 7515449.

STOPPING ENGINE

At the pilot's discretion, the flaps should be raised and the electric fuel pump turned off. After parking, the radios should be turned off and the engine stopped by putting the mixture control in idle cut-off. The throttle should be left full aft to avoid engine vibration while stopping. The magneto and master switches should be turned off and the parking brake set.

AIRSPEED DATA

All airspeeds quoted in this manual are calibrated unless otherwise noted. Calibrated airspeed is indicated airspeed corrected for instrument and position errors. The following table gives the correlation between indicated airspeed and calibrated airspeed if zero instrument error is assumed. This calibration is valid only when flown at maximum gross weight in level flight.

AIRSPEED CORRECTION TABLE

Flaps 0°										
IAS - MPH	60	70	80	90	100	110	120	130	140	150
CAS - MPH	66	74	82	90	99	108	117	126	135	144
Flaps 40°										
IAS - MPH	60	70	80	90	100	110				
CAS - MPH	65	73	81	89	98	107				

MOORING

The airplane can be moved on the ground with the aid of the optional nose wheel tow bar stowed in the baggage compartment. Tie-down ropes may be attached to rings under each wing and to the tail skid. The aileron and stabilator controls should be secured by looping the seat belt through the control wheel and pulling it snug. The rudder is held in position by its connection to the nose wheel steering and normally does not have to be secured. The flaps are locked when in the full up position and should be left retracted.

WEIGHT AND BALANCE

It is the responsibility of the owner and pilot to determine that the airplane remains within the allowable weight vs. center of gravity envelope while in flight. For weight and balance data, see the Weight and Balance Section of this manual.

EMERGENCY LOCATOR TRANSMITTER*

The Emergency Locator Transmitter (ELT) when installed, is located in the aft portion of the fuselage just below the stabilator leading edge and is accessible through a plate on the right side of the fuselage. (On aircraft manufactured prior to mid-1975, this plate is retained by three steel Phillips head screws. On aircraft manufactured from mid-1975 and on, this plate is attached with three slotted-head nylon screws for ease of removal; these screws may be readily removed with a variety of common items such as a dime, a key, a knife blade, etc. If there are no tools available in an emergency the screw heads may be broken off by any means.) The ELT is an emergency locator transmitter which meets the requirements of FAR 91.52. The unit operates on a self-contained battery.

The replacement date as required by FAA regulations is marked on the transmitter label. The battery should also be replaced if the transmitter has been used in an emergency situation or if accumulated test time exceeds one hour. The unit is equipped with a portable antenna to allow the locator to be removed from the airplane in case of an emergency and used as a portable signal transmitter.

On the unit itself is a three position selector switch placarded "OFF," "ARM," "ON." The "ARM" position is provided to set the unit to the automatic position so that it will transmit only after impact and will continue to transmit until the battery is drained to depletion or until the switch is manually moved to the "OFF" position. The "ARM" position is selected when the transmitter is installed at the factory and the switch should remain in that position whenever the unit is installed in the airplane. The "ON" position is provided so the unit can be used as a portable transmitter or in the event the automatic feature was not triggered by impact or to periodically test the function of the transmitter.

Select the "OFF" position when changing the battery, when rearming the unit if it has been activated for any reason, or to discontinue transmission.

NOTE

If the switch has been placed in the "ON" position for any reason, the "OFF" position has to be selected before selecting "ARM." If "ARM" is selected directly from the "ON" position the unit will continue to transmit in the "ARM" position.

A pilot's remote switch, located on the left side panel, is provided to allow the transmitter to be controlled from inside the cabin.

1. On some models the pilot's remote switch has three positions and is placarded "ON," "AUTO/ARM," and "OFF/RESET." The switch is normally left in the "AUTO/ARM" position. To turn the transmitter off, move the switch momentarily to the "OFF/RESET" position. The aircraft master switch must be "ON" to turn the transmitter "OFF." To activate the transmitter for tests or other reasons, move the switch upward to the "ON" position and leave it in that position as long as transmission is desired.
2. On other models the pilot's remote switch has two positions and is placarded "ON/RESET" and "ARM (NORMAL POSITION)." The switch is normally left in the down or "ARM" position. To turn the transmitter off, move the switch to the "ON/RESET" position for one second then return it to the "ARM" position. To

*Optional equipment

activate the transmitter for tests or other reasons, move the switch upward to the "ON/RESET" position and leave it in that position as long as transmission is desired.

The locator should be checked during the ground check to make certain the unit has not been accidentally activated. Check by tuning a radio receiver to 121.5 MHz. If there is an oscillating sound, the locator may have been activated and should be turned off immediately. Reset to the "ARM" position and check again to insure against outside interference.

NOTE

If for any reason a test transmission is necessary, the test transmission should be conducted only in the first five minutes of any hour and limited to three audio sweeps. If tests must be made at any other time, the tests should be coordinated with the nearest FAA tower or flight service station.

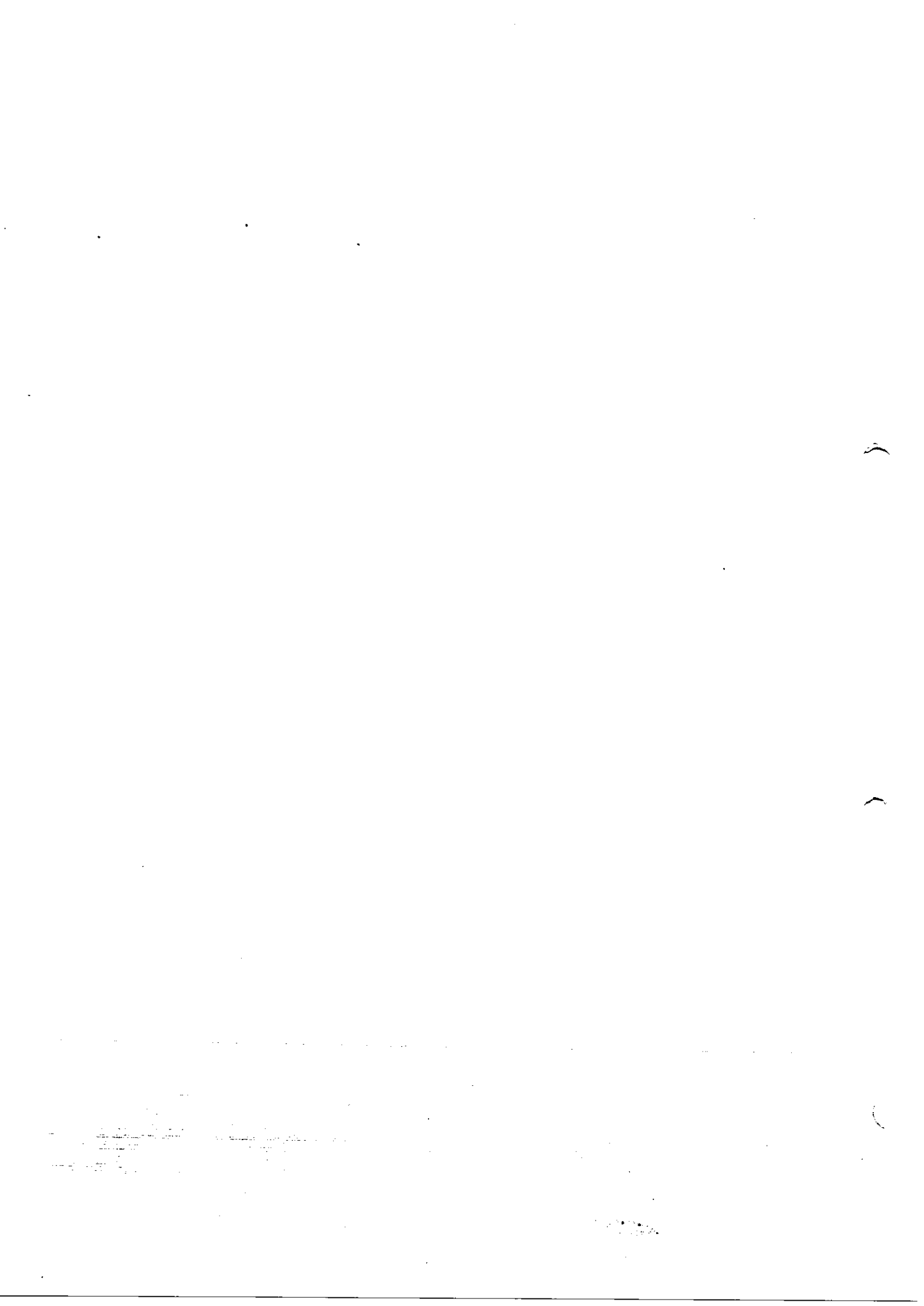

OPERATING TIPS

Operating Tips 8-1

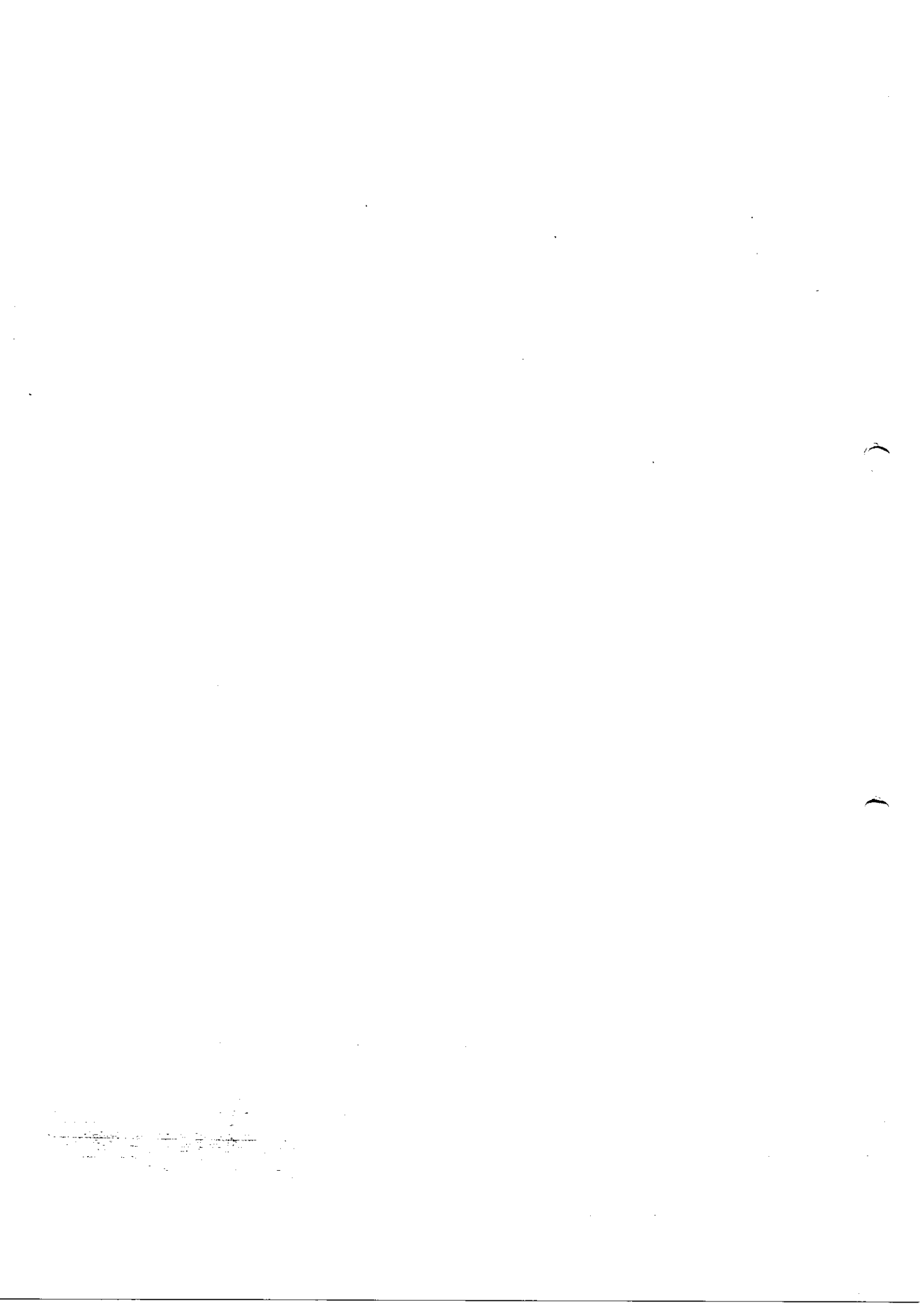

OPERATING TIPS

The following Operating Tips are of particular value in the operation of the airplane.

1. Learn to trim for takeoff so that only a slight back pressure on the wheel is required to lift the airplane from the ground.
2. The best speed for takeoff is about 60 MPH under normal conditions. Trying to pull the airplane off the ground at too low an airspeed decreases the controllability of the airplane in event of engine failure.
3. Flaps may be lowered at airspeeds up to 115 MPH**. To reduce flap operating loads, it is desirable to have the airplane at a slower speed before extending the flaps.
4. Before attempting to reset any circuit breaker, allow a two to five minute cooling off period.
5. Before starting the engine, check that all radio switches, light switches and the pitot heat switch are in the off position to prevent an overloaded condition when the starter is engaged.
6. The overvoltage relay protects the electronics equipment from a momentary overvoltage condition (approximately 16.5 volts and up), or a catastrophic regulator failure. In the event of a momentary condition, the relay will open and the ammeter will indicate "0" output from the alternator. The relay may be reset by switching the ALT switch to OFF for approximately 1 second and then returning the ALT switch to ON. The ALT light on the annunciator panel* will illuminate if the alternator fails. Recycle the ALT switch and check the ALT FIELD circuit breaker. If the failure persists after this action, reduce electrical loads and land as soon as practical.
7. The vacuum gauge monitors the pressure available to assure the correct operating speed of the vacuum driven gyroscopic flight instruments. It also monitors the condition of the common air filter by measuring the flow of air through the filter.
 If the vacuum gauge does not register $5'' \pm .10''$ Hg at 2000 RPM, the following items should be checked before flight:
 - a. Common air filter could be dirty or restricted.
 - b. Vacuum lines could be collapsed or broken.
 - c. Vacuum pump could be worn.
 - d. Vacuum regulator could be improperly adjusted. The pressure, even though set correctly, can read lower under two conditions: (1) Very high altitude - above 12000 feet, (2) Low engine RPM - usually on approach or during training maneuvers. This is normal and should not be considered a malfunction.
8. The shape of the wing fuel tanks is such that in certain maneuvers the fuel may move away from the tank outlet. If the outlet is uncovered, the fuel flow will be interrupted and a temporary loss of power may result. Pilots can prevent inadvertent uncovering of the outlet by avoiding maneuvers which could result in uncovering the outlet.

Extreme running turning takeoffs should be avoided as fuel flow interruption may occur.

Prolonged slips or skids which result in excess of 2000 feet of altitude loss, or other radical or extreme maneuvers which could cause uncovering of the fuel outlet must be avoided as fuel flow interruption may occur when tank being used is not full.

*Serial nos. 7515001 and up

**125 MPH on serial nos. 7415001 through 7515449

CHEROKEE WARRIOR

9. Anti-collision lights should not be operating when flying through overcast and clouds, since reflected light can produce spacial disorientation. Do not operate strobe lights when taxiing in the vicinity of other aircraft.
10. The rudder pedals are suspended from a torque tube which extends across the fuselage. The pilot should become familiar with the proper positioning of his feet on the rudder pedals so as to avoid interference with the torque tube when moving the rudder pedals or operating the toe brakes.
11. In an effort to avoid accidents, pilots should obtain and study the safety related information made available in FAA publications such as regulations, advisory circulars, Aviation News, AIM and safety aids.
12. During letdown and low power flight operations, it may be necessary to lean because of excessively rich mixture. Always go to full rich prior to landing sequence.
13. When leaning, careful observation of the temperature instruments should be practiced.
14. When alternate fuels are used, the engine should be run up to 1200 RPM for one minute prior to shutdown to clean out any unburned fuel.

PERFORMANCE CHARTS

Altitude Conversion Chart	9-1
Takeoff Performance	9-2
Climb Performance	9-3
Engine Performance	9-4
Cruise Performance - True Airspeed (Best Power)	9-5
Cruise Performance - True Airspeed (Best Economy)	9-6
Cruise Performance - Range (Best Power)	9-7
Cruise Performance - Range (Best Economy)	9-8
Stall Speed vs Weight	9-9
Stall Speed vs Angle of Bank	9-10
Glide Performance	9-11
Landing Performance	9-12

WARNING

Performance information derived by extrapolation beyond the limits shown on the charts should not be used for flight planning purposes.

PA-28-151 CHEROKEE

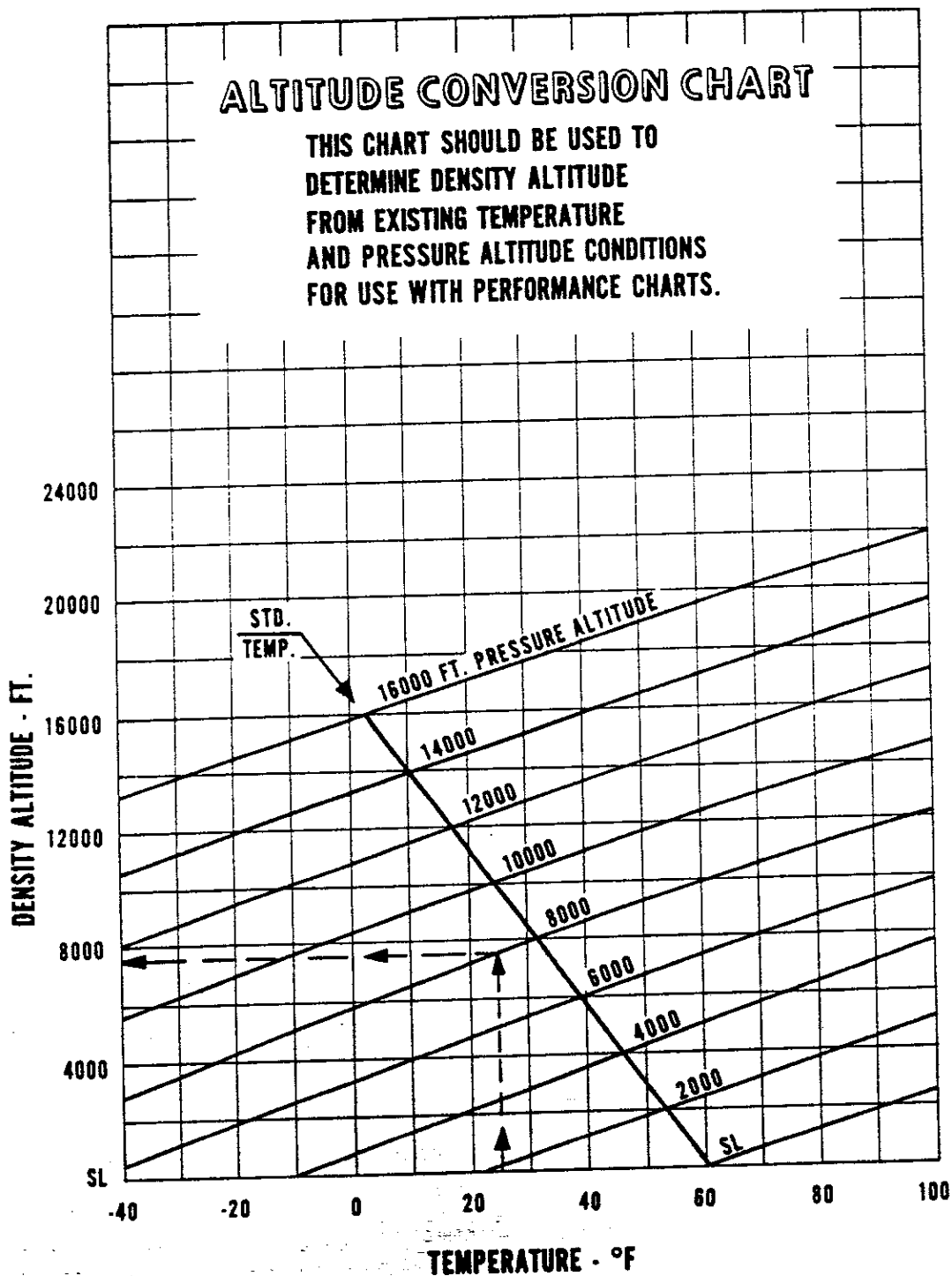

PERFORMANCE CHARTS
ISSUED: JULY 17, 1973

PA-28-151 CHEROKEE

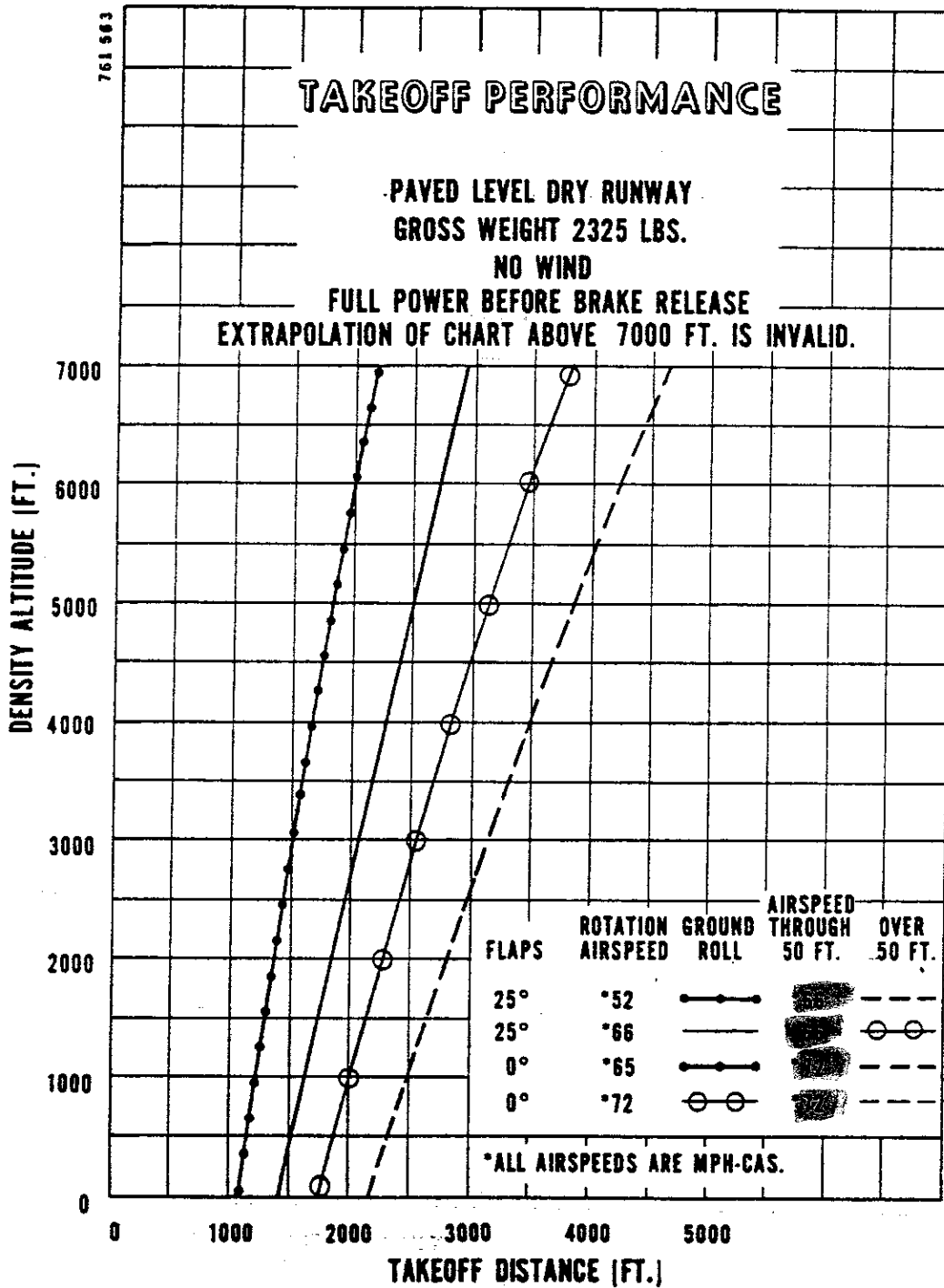

PA-28-151 CHEROKEE

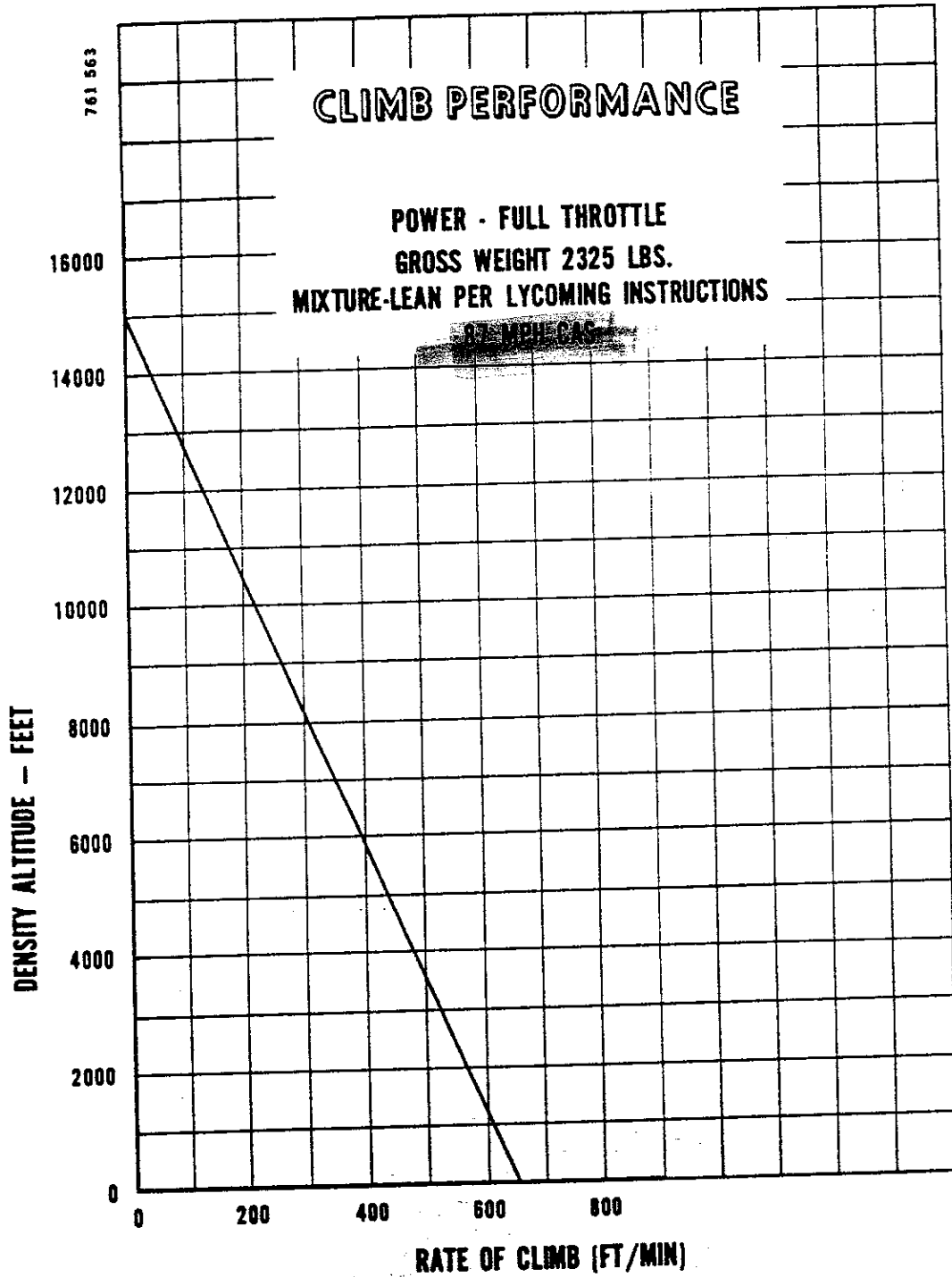

PA-28-151 CHEROKEE

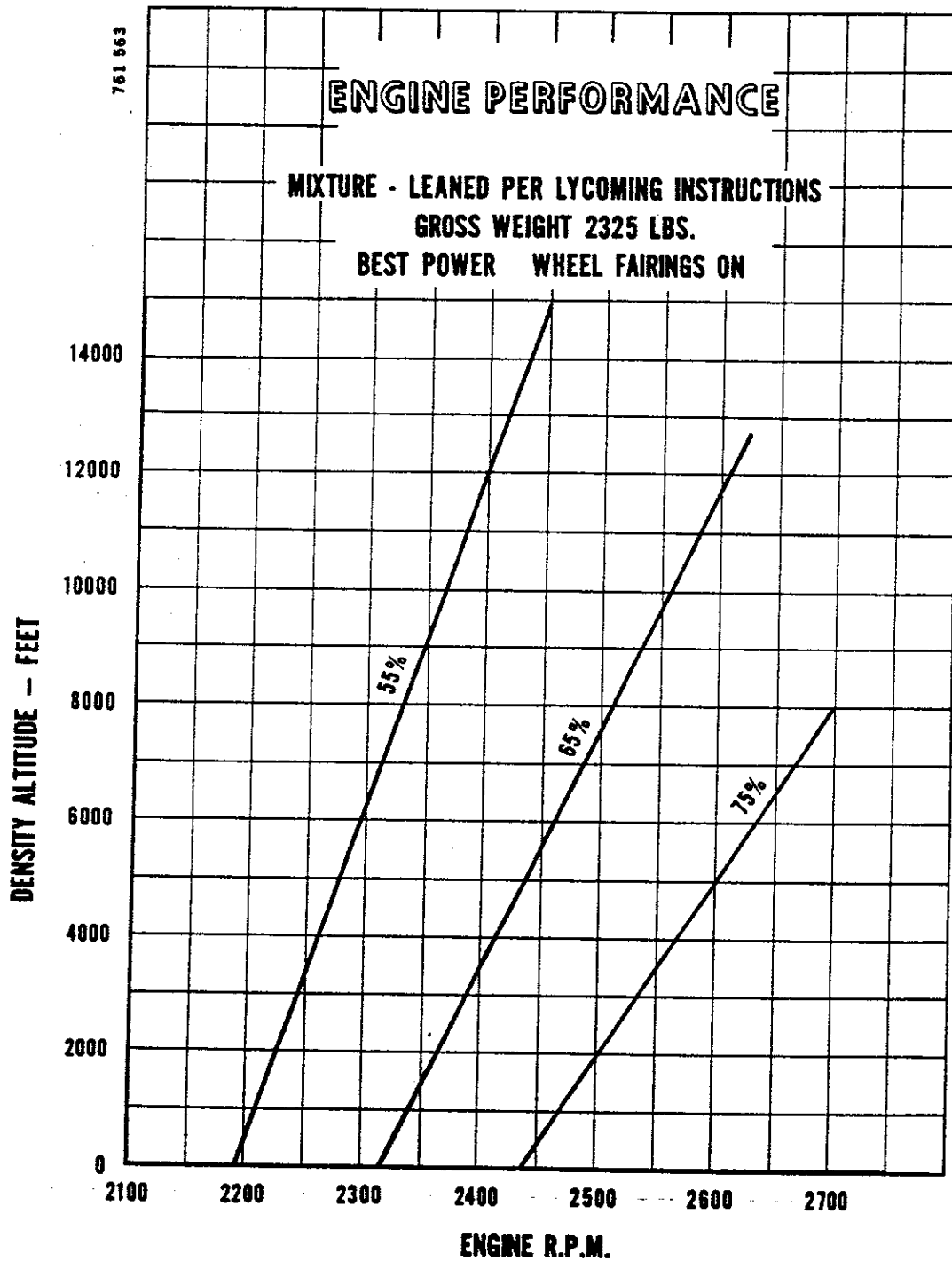

PA-28-151 CHEROKEE

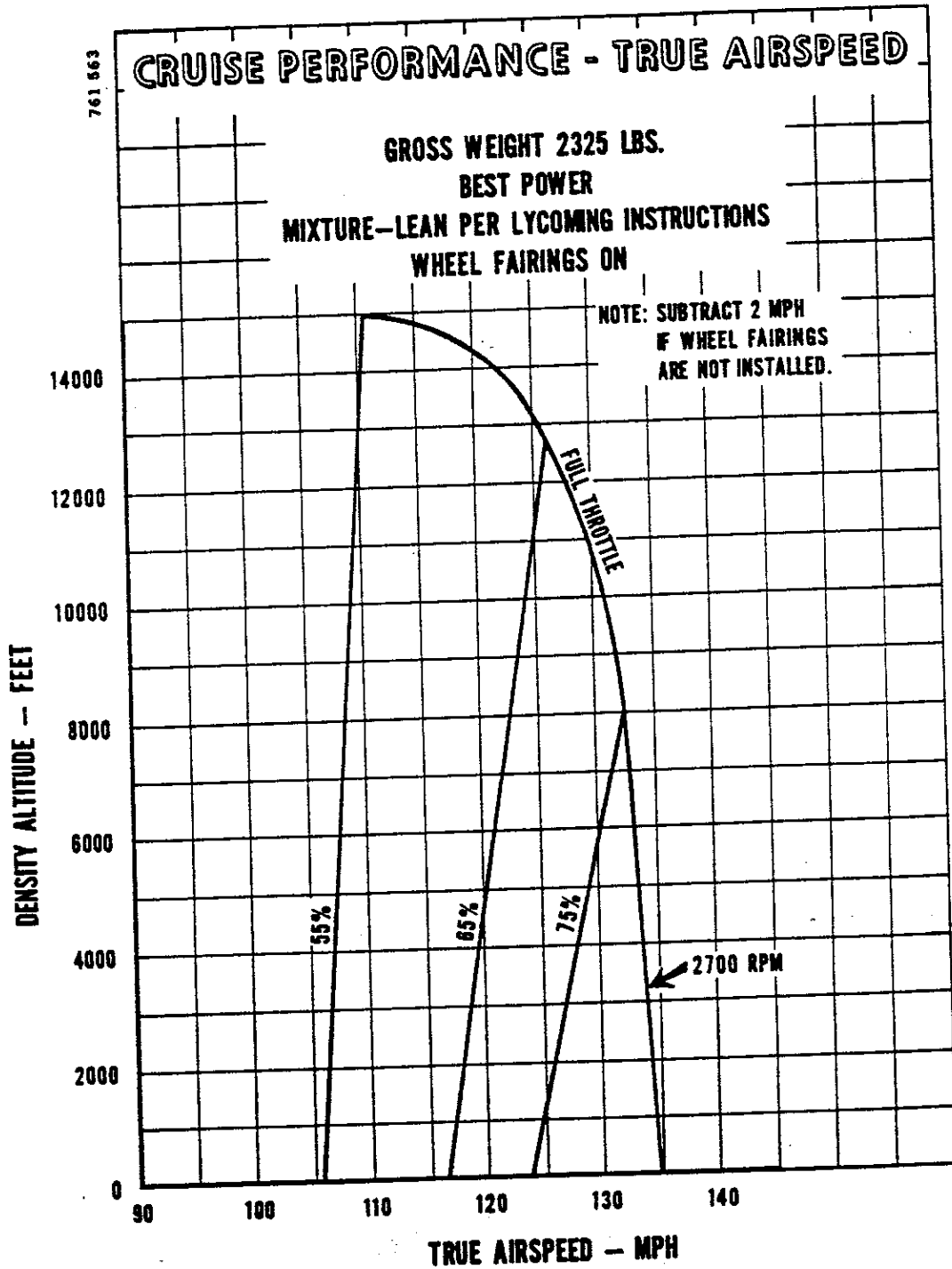

PA-28-151 CHEROKEE

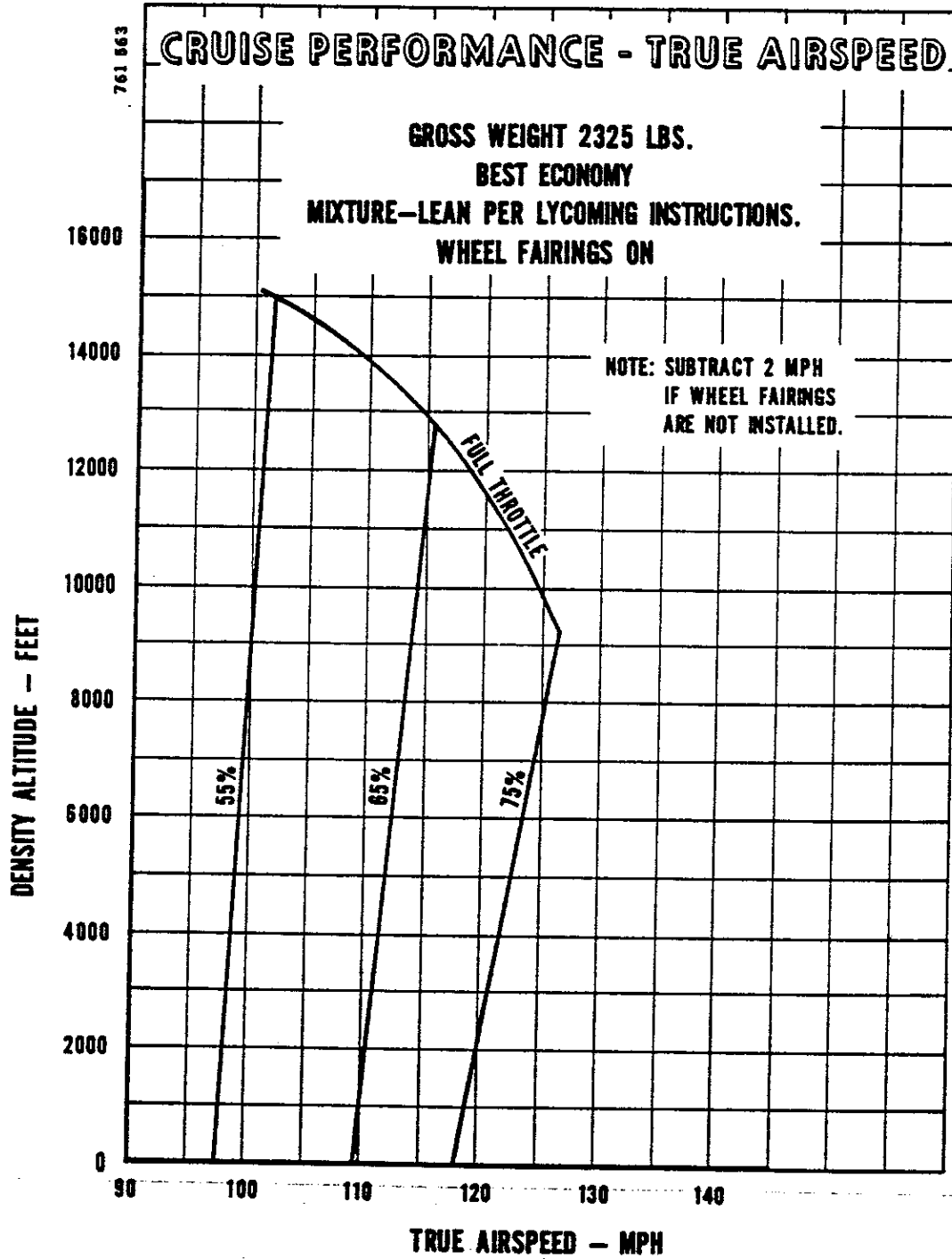

PA-28-151 CHEROKEE

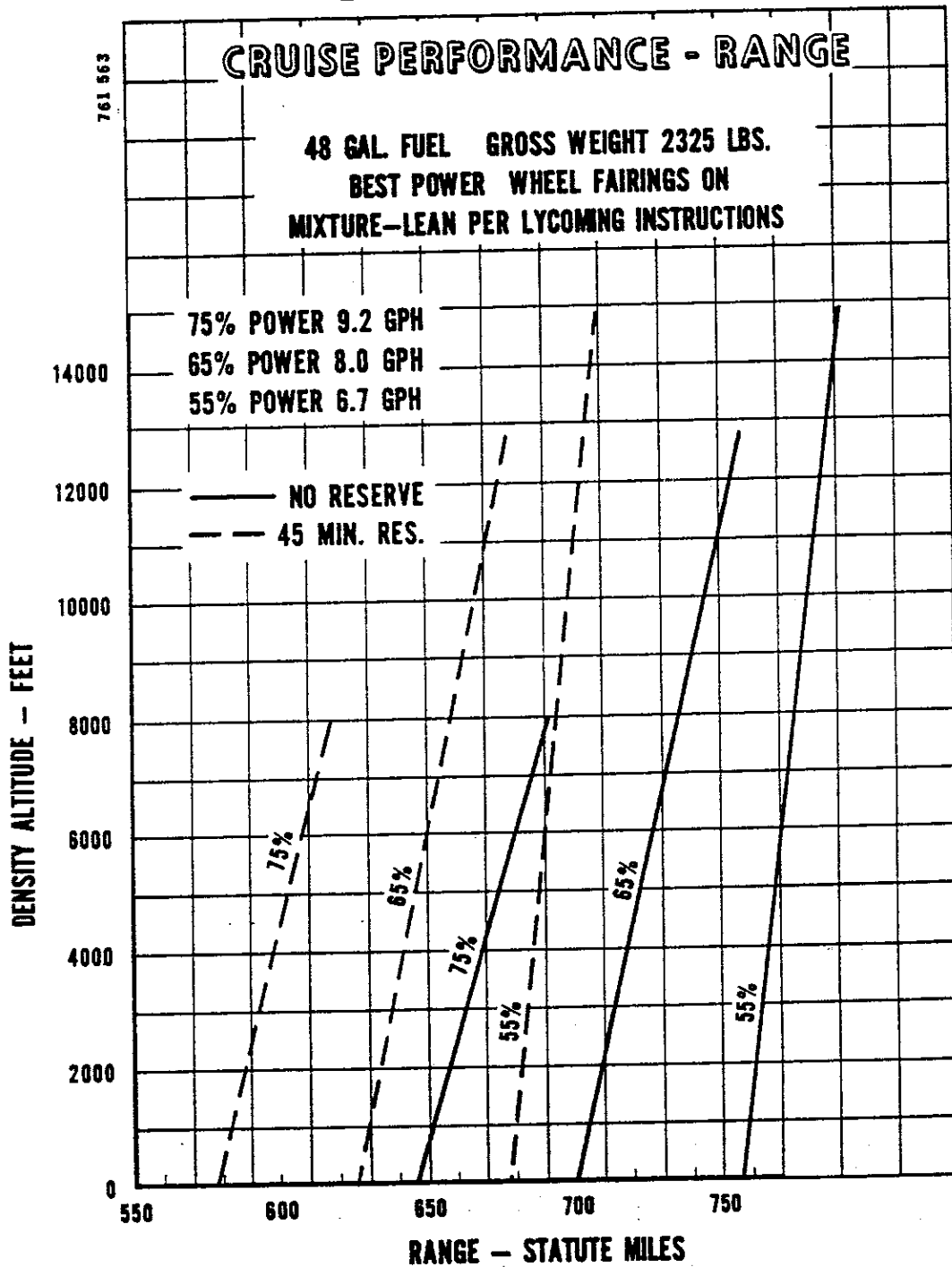

PA-28-151 CHEROKEE

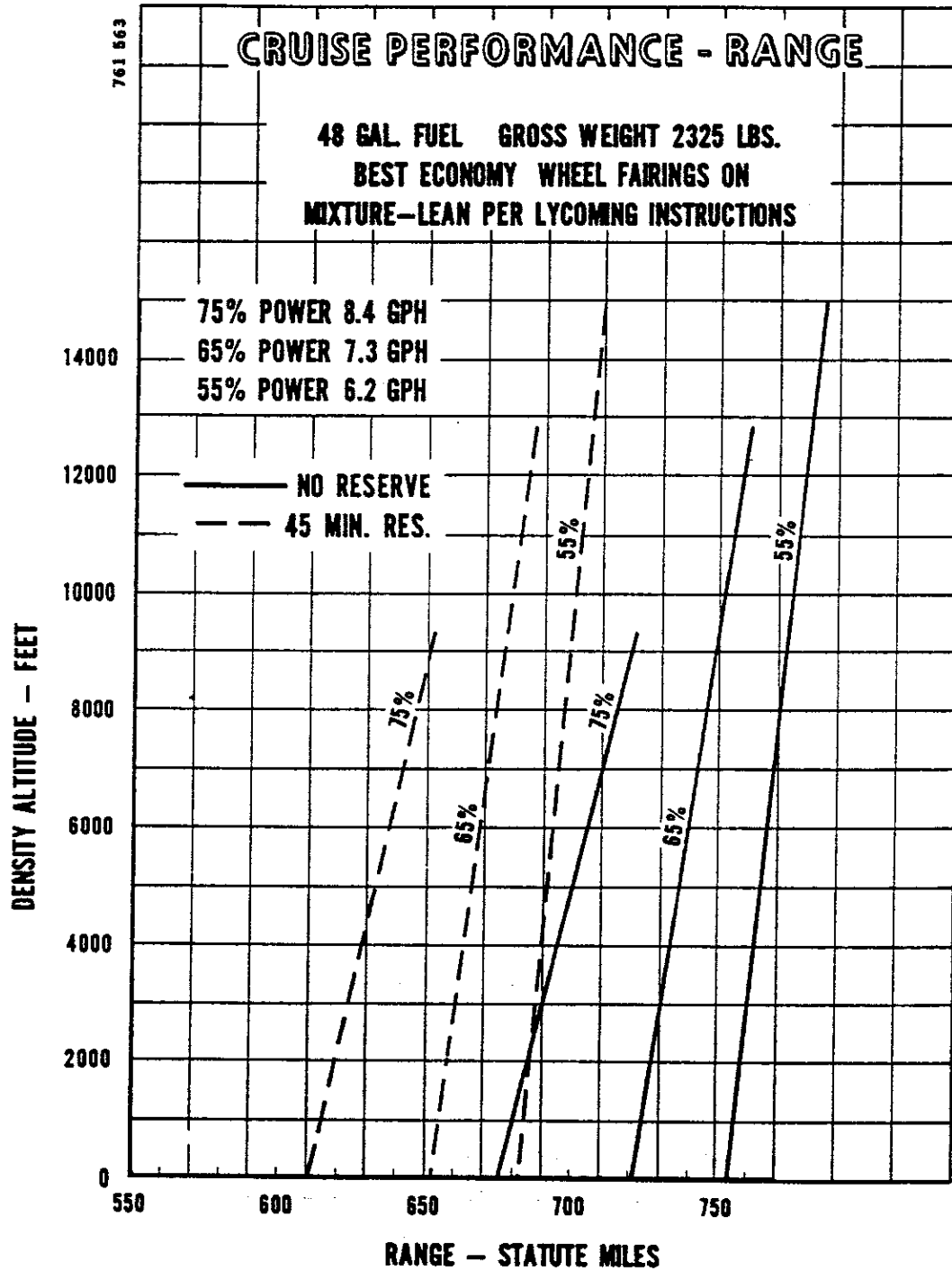

PA-28-151 CHEROKEE

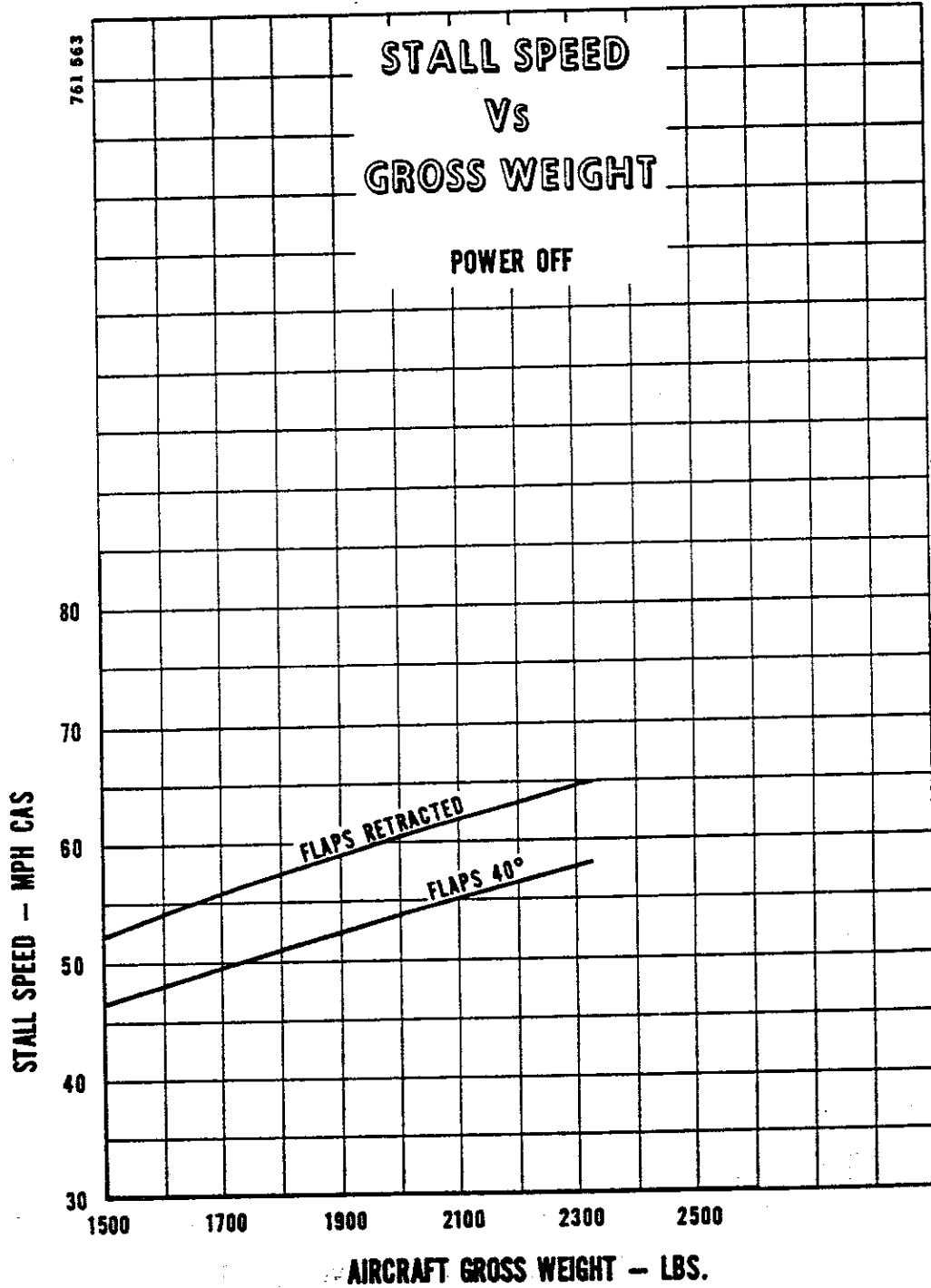

PA-28-151 CHEROKEE

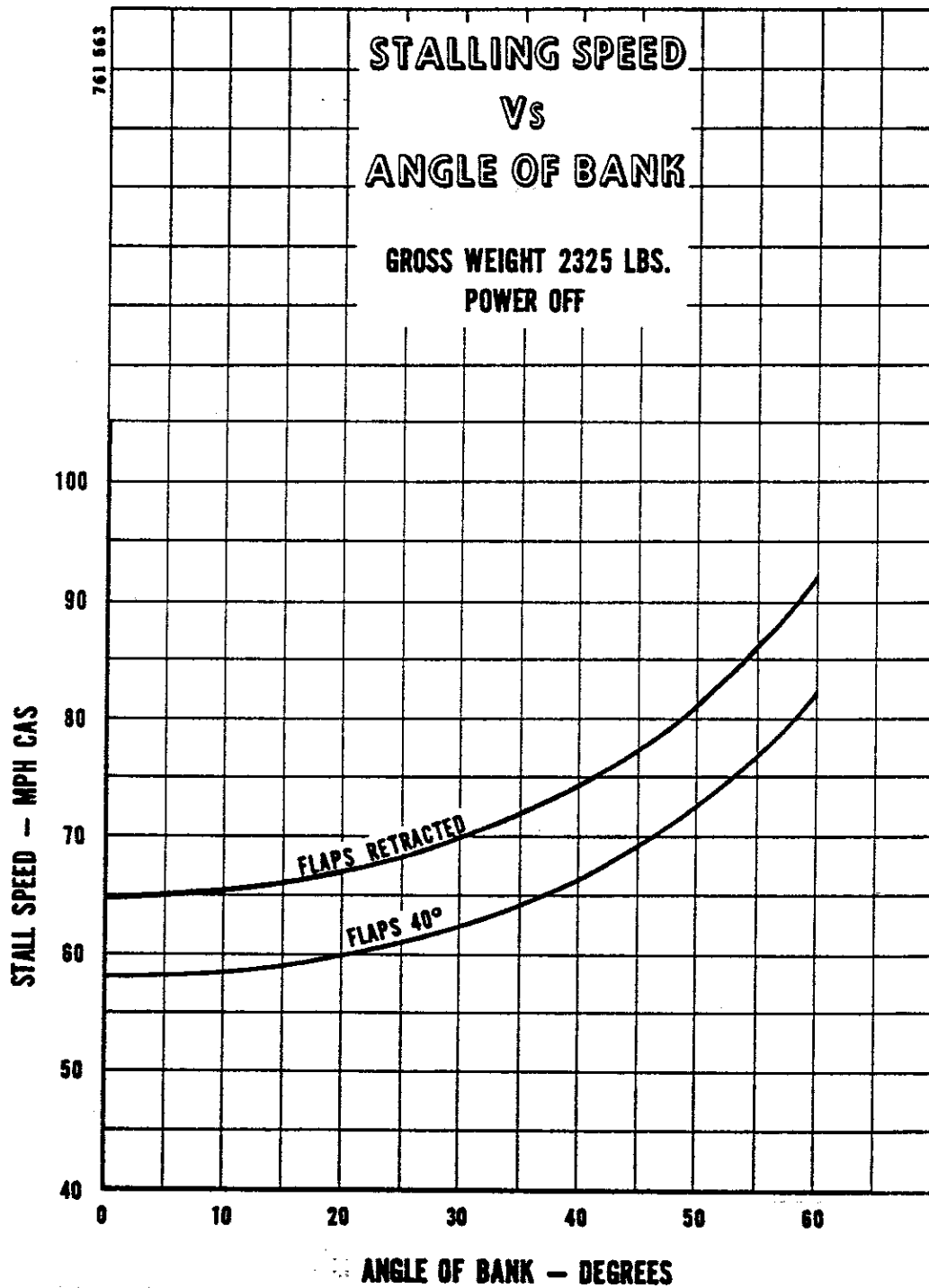

PA-28-151 CHEROKEE

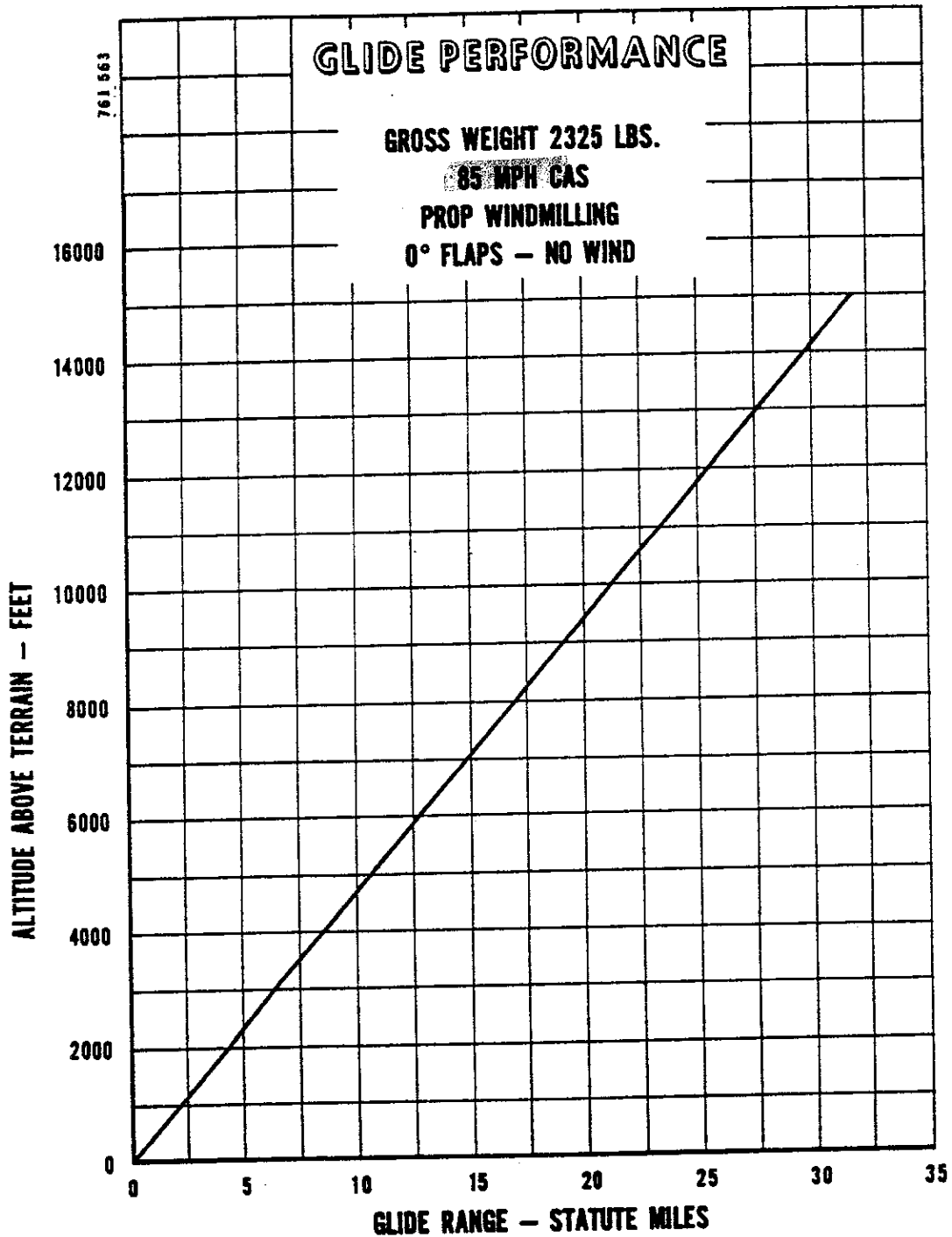

PA-28-151 CHEROKEE

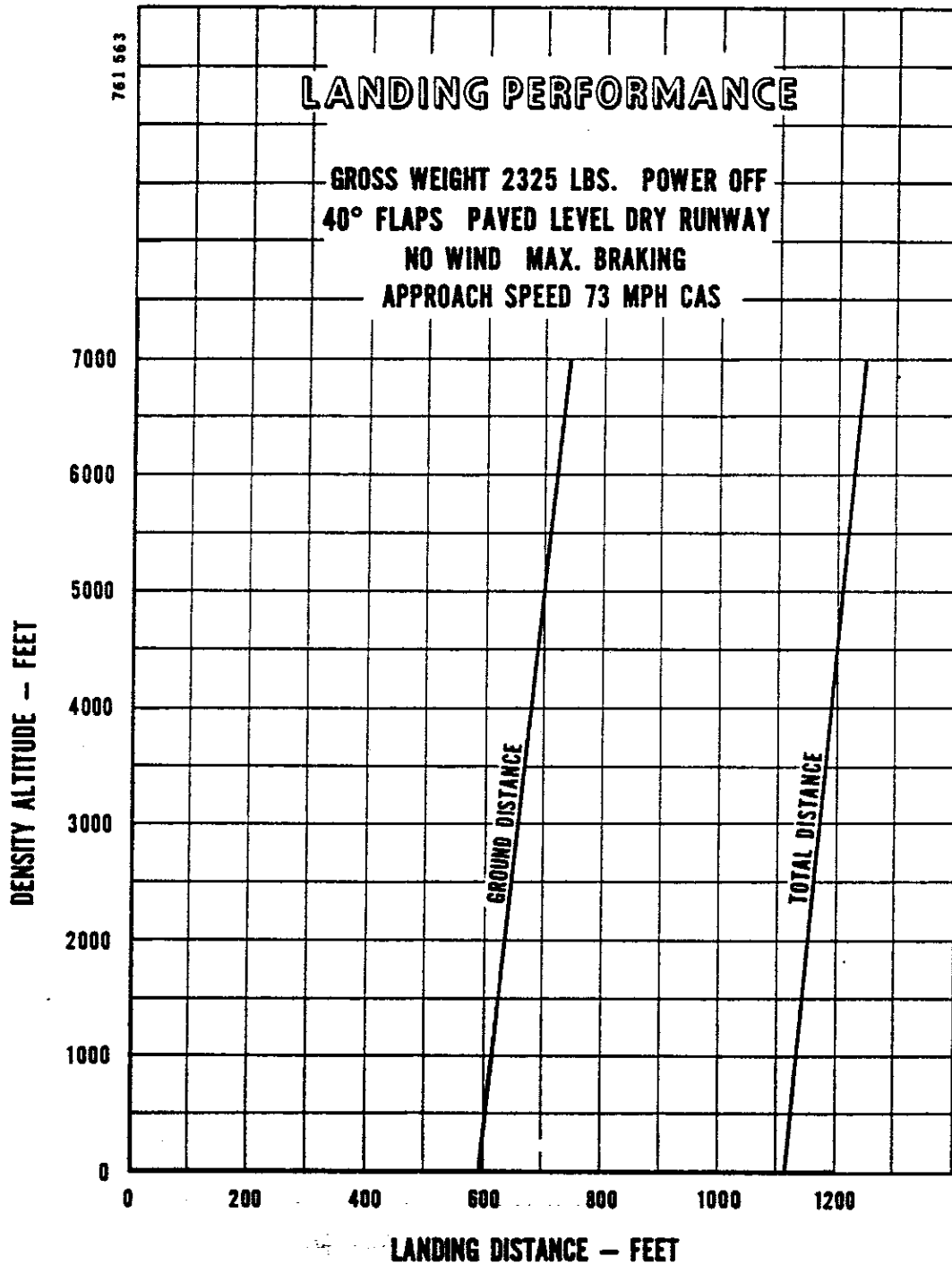

HANDLING AND SERVICING

Ground Handling	10-1
Towing	10-1
Taxiing	10-1
Parking	10-2
Mooring	10-2
Cleaning	10-3
Cleaning Engine Compartment	10-3
Cleaning Landing Gear	10-3
Cleaning Exterior Surfaces	10-4
Cleaning Windshield and Windows	10-4
Cleaning Headliner, Side Panels and Seats	10-4
Cleaning Carpets	10-5
Power Plant Induction Air Filter	10-5
Removal of Induction Air Filter	10-5
Installation of Induction Air Filter	10-5
Brake Service	10-7
Landing Gear Service	10-7
Propeller Service	10-8
Oil Requirements	10-8
Fuel System	10-9
Servicing Fuel System	10-9
Fuel Requirements	10-9
Filling Fuel Tanks	10-10
Draining Fuel Valves and Lines	10-10
Draining Fuel System	10-11
Tire Inflation	10-11
Battery Service	10-11
Winterization	10-11
Facts You Should Know	10-12
Preventive Maintenance	10-14
Required Service and Inspection Periods	10-15



HANDLING AND SERVICING

This section contains information on preventive maintenance. Refer to the PA-28-151 Service Manual for further maintenance procedures. Any complex repair or modification should be accomplished by a Piper Certified Service Center.

GROUND HANDLING

TOWING

The airplane may be moved by using the nose wheel tow bar available with the airplane, or by power equipment that will not damage or cause excess strain to the nose gear assembly. The tow bar is stowed in the baggage compartment.

CAUTION

When towing with power equipment, do not turn the nose gear beyond its turning radius in either direction as this will result in damage to the nose gear and steering mechanism.

CAUTION

Do not tow the airplane when the controls are secured.

TAXIING

Before attempting to taxi the airplane, ground personnel should be instructed and approved by a qualified person authorized by the owner. Engine starting and shut-down procedures and taxiing techniques should be covered. When it is ascertained that the propeller back blast and taxi areas are clear, power should be applied to start the taxi roll, and the following checks should be performed:

- a. Taxi forward a few feet and apply the brakes to determine their effectiveness.
- b. While taxiing, make slight turns to ascertain the effectiveness of the steering.
- c. Observe wing clearances when taxiing near buildings or other stationary objects. If possible, station an observer outside to guide the airplane.
- d. When taxiing on uneven ground, avoid holes and ruts.
- e. Do not operate the engine at high RPM when running up or taxiing over ground containing loose stones, gravel, or any loose material that might cause damage to the propeller blades.

PARKING

When parking the airplane, be sure that it is sufficiently protected from adverse weather conditions and that it presents no danger to other aircraft. When parking the airplane for any length of time or overnight, it is suggested that it be moored securely.

- a. To park the airplane, head it into the wind if possible.
- b. Set the parking brake by pulling back on the brake lever and depressing the knob on the handle. To release the parking brake, pull back on the handle until the catch disengages; then allow the handle to swing forward.

CAUTION

Care should be exercised when setting brakes that are overheated or during cold weather when accumulated moisture may freeze a brake.

- c. Aileron and stabilator controls may be secured with the front seat belt. Wheel chocks may be used if they are available.

MOORING

The airplane should be moored for immovability, security, and protection. The following procedures should be used for the proper mooring of the airplane:

- a. Head the airplane into the wind, if possible.
- b. Retract the flaps.
- c. Immobilize the ailerons and stabilator by looping the seat belt through the control wheel and pulling it snug.
- d. Block the wheels.
- e. Secure tie-down ropes to the wing tie-down rings and to the tail skid at approximately 45 degree angles to the ground. When using rope of non-synthetic material, leave sufficient slack to avoid damage to the airplane should the ropes contract.

CAUTION

Use bowline knots, square knots, or locked slip knots. Do not use plain slip knots.

NOTE

Additional preparations for high winds include using tie-down ropes from the landing gear forks and securing the rudder.

- f. Install a pitot head cover if one is available. Be sure to remove the pitot head cover before flight.
- g. Cabin and baggage doors should be locked when the airplane is unattended.

CLEANING

CLEANING ENGINE COMPARTMENT

Before cleaning the engine compartment, place a strip of tape over the magneto vents to prevent any solvent from entering these units.

- a. Place a large pan under the engine to catch waste.
- b. With the engine cowling removed, spray or brush the engine with solvent or a mixture of solvent and degreaser. In order to remove especially heavy dirt and grease deposits, it may be necessary to brush areas that were sprayed.

CAUTION

Do not spray solvent into the alternator, vacuum pump, starter, or air intakes.

- c. Allow the solvent to remain on the engine from five to ten minutes. Then rinse the engine clean with additional solvent and allow it to dry.

CAUTION

Do not operate the engine until excess solvent has evaporated or otherwise been removed.

- d. Remove the protective tape from the magnetos.
- e. Lubricate the controls, bearing surfaces, etc., in accordance with the Lubrication Chart.

CLEANING LANDING GEAR

Before cleaning the landing gear, place a cover of plastic or a similar waterproof material over the wheel and brake assembly.

- a. Place a pan under the gear to catch waste.
- b. Spray or brush the gear area with solvent or a mixture of solvent and degreaser. In order to remove especially heavy dirt and grease deposits, it may be necessary to brush areas that were sprayed.
- c. Allow the solvent to remain on the gear from five to ten minutes. Then rinse the gear with additional solvent and allow it to dry.
- d. Remove the cover from the wheel and remove the catch pan.
- e. Lubricate the gear in accordance with the Lubrication Chart.

CLEANING EXTERIOR SURFACES

The airplane should be washed with a mild soap and water. Harsh abrasives or alkaline soaps or detergents could make scratches on painted or plastic surfaces or could cause corrosion of metal. Cover areas where cleaning solution could cause damage. To wash the airplane, use the following procedure:

- a. Flush away loose dirt with water.
- b. Apply cleaning solution with a sponge, a soft cloth, or a soft bristle brush.
- c. To remove exhaust stains, allow the solution to remain on the surface longer.
- d. To remove stubborn oil and grease stains use a cloth dampened with naphtha.
- e. Rinse all surfaces thoroughly.
- f. Any good automotive wax may be used to protect and preserve painted surfaces. Soft cleaning cloths or a chamois should be used to prevent scratches when cleaning or polishing. A heavier coating of wax on the leading surfaces will reduce the abrasion problems in these areas.

CLEANING WINDSHIELD AND WINDOWS

A certain amount of care is needed to keep the windows clean and unmarred. The following procedure is recommended:

- a. Remove dirt, mud, and other loose particles from exterior surfaces with clean water.
- b. Wash with mild soap and clean water or with aircraft plastic cleaner. Use a soft cloth or sponge in a straight back and forth motion. Do not rub harshly.
- c. Remove oil or grease with a cloth moistened with kerosene.

CAUTION

Do not use gasoline, alcohol, benzene, carbon tetrachloride, thinner, acetone, or window cleaning sprays.

- d. After cleaning plastic surfaces, apply a thin coat of hard polishing wax. Rub lightly with a soft cloth. Do not use a circular motion.
- e. A severe scratch or mar in plastic can be removed by rubbing out the scratch with jeweler's rouge. Smooth both sides and apply wax.

CLEANING HEADLINER, SIDE PANELS AND SEATS

- a. Clean headliner, side panels and seats with a whisk broom, dusting cloth, or a vacuum cleaner.
- b. Soiled upholstery may be cleaned with a good upholstery cleaner suitable for the material. Carefully follow the manufacturer's instructions. Avoid soaking or harsh rubbing.

CAUTION

Solvent cleaners require adequate ventilation.

CLEANING CARPETS

To clean carpets, first remove loose dirt with a vacuum or a whisk broom. For soiled spots and stubborn stains use a nonflammable dry cleaning fluid. Floor carpets may be removed and cleaned like any household carpet.

POWER PLANT INDUCTION AIR FILTER

The wet-type polyurethane foam air filter must be inspected at least once every fifty hours. Under extremely adverse operating conditions, it may be necessary to inspect the filter more frequently. The filter is disposable and inexpensive and a spare should be kept on hand for a rapid replacement.

REMOVAL OF INDUCTION AIR FILTER

The filter is located in the lower right front of the engine compartment and may be removed by the following procedure:

- a. Open the right side of the engine cowling.
- b. Loosen each of the four quarter-turn fasteners securing the air filter cover.
- c. Separate the cover and remove the filter.
- d. Inspect the filter. If it is excessively dirty or shows any damage, replace it immediately.

INSTALLATION OF INDUCTION FILTER

When replacing the filter, install the filter in the reverse order of removal.

1. BRAKE RESERVOIR
2. RIGHT BRAKE AND RUDDER PEDAL
3. LEFT BRAKE AND RUDDER PEDAL
4. RIGHT BRAKE CYLINDER
5. LEFT BRAKE CYLINDER
6. BRAKE HANDLE
7. HANDLE RELEASE BUTTON
8. LINE, INLET
9. CLEVIS PIN
10. MASTER CYLINDER ASSEMBLY
11. BOLT ASSEMBLY
12. TORQUE TUBE
13. COPILOT'S RIGHT BRAKE AND RUDDER PEDAL
14. COPILOT'S LEFT BRAKE AND RUDDER PEDAL

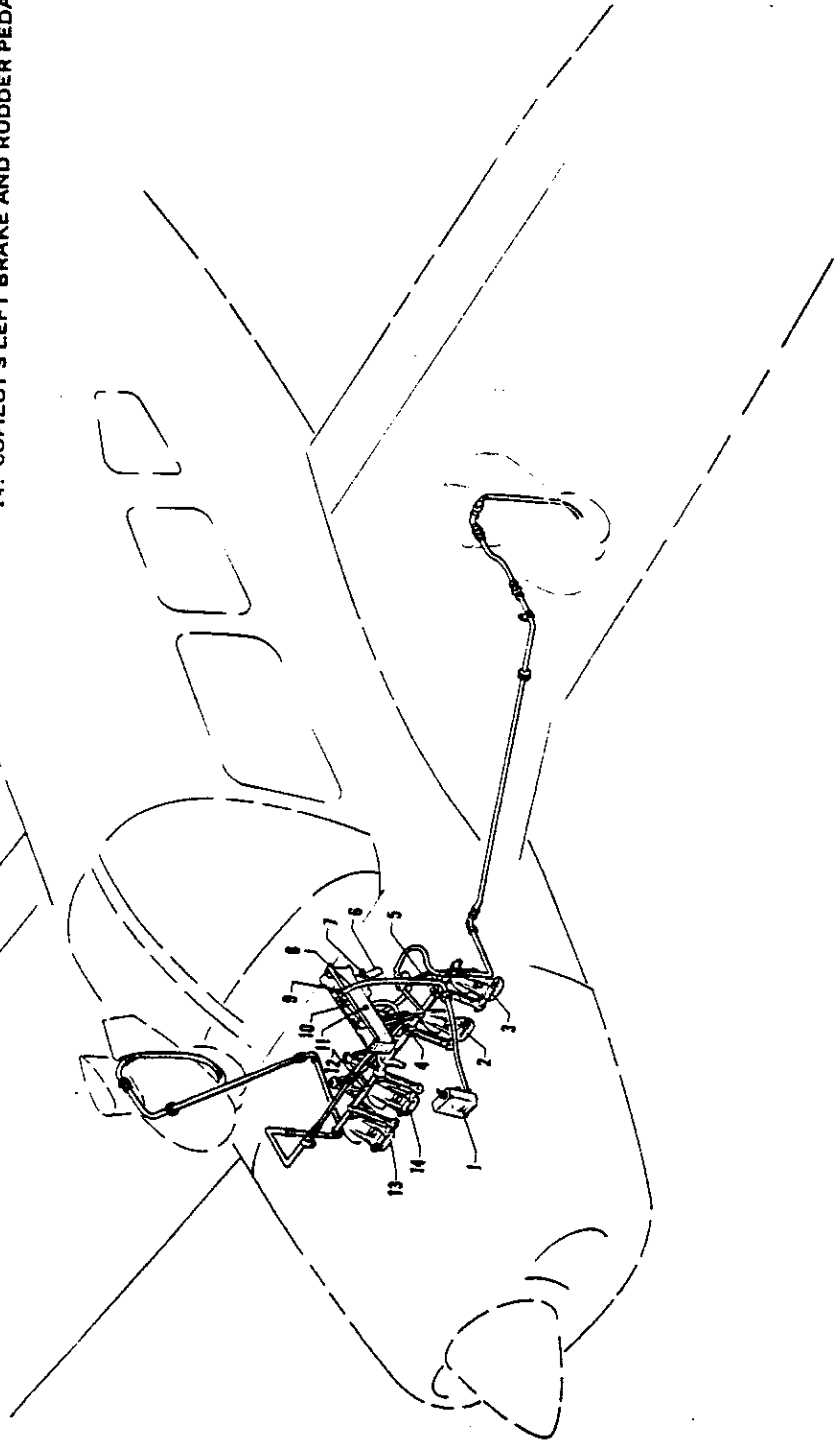

Brake System

BRAKE SERVICE

The brake system is filled with MIL-H-5606 (petroleum base) hydraulic brake fluid. The fluid level should be checked periodically or at each 50 hour inspection and replenished when necessary. The brake reservoir is located on the upper left side of the fire wall in the engine compartment. If the entire system must be refilled, fill with fluid under pressure from the brake end of the system. This will eliminate air from the system.

No adjustment of brake clearances is necessary. If after extended service brake blocks become excessively worn, they should be replaced with new segments.

LANDING GEAR SERVICE

The main landing gears use Cleveland 6.00 x 6 wheels, and the nose gear carries a Cleveland 5.00 x 5 wheel. All three tires are 4 ply rating, Type III tires with tubes; the main gear tires are 6.00 x 6 and the nose gear tire is 5.00 x 5. (See Tire Inflation, this Section.)

Main wheels are removed by taking off the hub cap, pin, axle nut, and the two bolts holding the brake segment in place, after which the wheel slips easily from the axle.

The nose wheel is removed by taking off the axle nut and washer from one side, sliding out the axle rod and plugs, lightly tapping out the axle tube, and then removing the wheel and spacer tubes from between the fork. Wheels are replaced by reversing the procedure.

Tires are removed from the wheels by deflating the tire, removing the through bolts, and separating the wheel halves.

Landing gear oleo struts should be checked for proper strut exposure and visible leaks. The required extensions for the struts under normal static load (empty weight of airplane plus full fuel and oil) are 3.25 inches for the nose gear and 4.50 inches for the main gear. If the strut exposure is below that required, it should be determined whether air or oil is needed by first raising the airplane on jacks. Depress the valve core to allow air to escape from the strut housing chamber. Remove the filler plug and slowly raise the strut to full compression. If the fluid is then visible up to the bottom of the filler plug hole, only proper extension with air is required.

If fluid is below the bottom of the filler plug hole, oil should be added. Replace the plug with the valve core removed. Then attach a clear plastic hose to the valve stem of the filler plug and submerge the other end in a container of hydraulic fluid (MIL-H-5606). Fully compress and extend the strut several times, thus drawing fluid from the container and expelling air. The torque link assembly must be disconnected to let the strut be extended a minimum of 10 inches. (The nose gear torque links need not be disconnected.) DO NOT allow the strut to extend beyond 12 inches. When air bubbles cease to flow through the hose, fully compress the strut, remove the filler plug, and again check the fluid level. When the fluid level is correct, disconnect the hose, reinstall the valve core, the filler plug, and the main gear torque links.

With the fluid in the strut housing at the proper level, attach a strut pump to the air valve. With the airplane on the ground under normal static load, inflate the oleo strut to the proper strut exposure.

CHEROKEE WARRIOR

In jacking the airplane for landing gear or other service, two hydraulic jacks and a tail stand should be used. At least 250 pounds of ballast should be placed on the tail stand before jacking the airplane. The hydraulic jacks are placed under the jack points on the underside of the wings, and the airplane is jacked up until the tail stand can be attached to the tail skid. After attaching the tail stand and adding the ballast, the jacking can be continued until the airplane is at the desired height.

The steering arms from the rudder pedals to the nose gear are adjusted at the rudder pedals or at the nose wheel by turning in or out the threaded rod end bearings. Adjustments are normally made at the forward end of the rods and should be done in such a way that the nose wheel is in line with the fore and aft axis of the airplane when the rudder pedals and rudder are centered. Alignment of the nose wheel can be checked by pushing the airplane back and forth with the rudder centered to determine that the plane follows a perfectly straight line.

The turning arc of the nose wheel is 30 degrees either side of center and is factory adjusted at stops on the bottom of the forging. The turning radius of the nose wheel is 13 feet.

The rudder bar stops should be carefully adjusted so that the rudder bar reaches its full travel just after the rudder hits its stops. This guarantees that the rudder will be allowed to move through its full travel.

PROPELLER SERVICE

The spinner and backing plate should be cleaned and inspected for cracks frequently. Before each flight the propeller should be inspected for nicks, scratches, or corrosion. If found, they should be repaired as soon as possible by a rated mechanic, since a nick or scratch causes an area of increased stress which can lead to serious cracks or the loss of a propeller tip. The back face of the blades should be painted when necessary with flat black paint to retard glare. To prevent corrosion, all surfaces should be cleaned and waxed periodically.

OIL REQUIREMENTS

The oil capacity of the Lycoming O-320-E3D series engines is 8 quarts and the minimum safe quantity is 2 quarts. On engines equipped with a pressure screen system, it is recommended that the oil be changed and screen cleaned every 25 hours. On engines equipped with a fuel-flow pressure system, it is recommended that the oil be changed and filter replaced every 50 hours. On engines using either filtration system, it is recommended that the oil be changed and screen cleaned or filter replaced more frequently under unfavorable operating conditions. Time periods between oil changes should not exceed four months.

The following grades are recommended for the specified temperatures:

Temperatures	Single Viscosity Grade	Multi-Viscosity Grade
Above 60° F	SAE 50	SAE 40 or SAE 50
Between 30° and 90° F	SAE 40	SAE 40
Between 0° and 70° F	SAE 30	SAE 40 or 20W-30
Below 10° F	SAE 20	SAE 20W-30



Anhang zum Flughandbuch
für
PIPER-PA-28-140, PA-28-150, PA-28-151 Cherokee

Kennzeichen: ~~D-CE~~ *CE-D114*

Werk-Nr.: *28-7415449*

Dieser Anhang muss dem offiziell genehmigten Flughandbuch des oben eingetragenen Flugzeug beigefügt sein, wenn das Flugzeug durch EMZ-Nr.: SA 1232 modifiziert wurde. Die in diesem Anhang enthaltenen Informationen ergänzen oder ersetzen diejenigen des Originalhandbuches nur in den folgenden Bereichen. Für Beschränkungen, Verfahren und Leistungsangaben, die in diesem Anhang nicht enthalten sind, ist das Originalhandbuch zu konsultieren.

Beschränkungen / Limitations

Kraftstoff: Zusätzlich zu den im Original-Flughandbuch aufgeführten Kraftstoffen sind folgende Kraftstoffe zugelassen:

Unverbleiter Automobilkraftstoff nach DIN EN 228 ROZ 98
Unverbleiter Automobilkraftstoff gemäß ASTM Spezifikation D-439 mit einem Antiknockindex von mindestens 91 Oktan (ROZ+MOZ)/2

Verbleiter Automobilkraftstoff gemäß ASTM Spezifikation D-439 mit einem Antiknockindex von mindestens 91 Oktan (ROZ+MOZ)/2

Das Mischen mit AVGAS Flugzeugkraftstoff ist gestattet.

Anmerkung: *Es dürfen nur Kraftstoffe mit einem Alkoholgehalt von maximal 1% verwendet werden! Falls diese Information nicht vorliegt bzw. dieser Kraftstoff nicht verfügbar ist, muss AVGAS getankt werden (entsprechend den Angaben des Flughandbuches).
Kraftstoff nach DIN EN 228 kann bis zu 5 % Alkohol enthalten*

Beschriftung: Neben den bestehenden AVGAS-Beschriftungen ist an jeder Tankeinfüllöffnung ein Aufkleber mit dem folgenden Text anzubringen:

Unverbleites Autobenzin
Minimum 98 ROZ
nach DIN EN 228 oder gemäß FAA
STC

Alkoholgehalt max. 1 %
Mischen mit AVGAS gestattet

Vom Luftfahrt-Bundesamt genehmigt:



Datum:

7. Juni 02

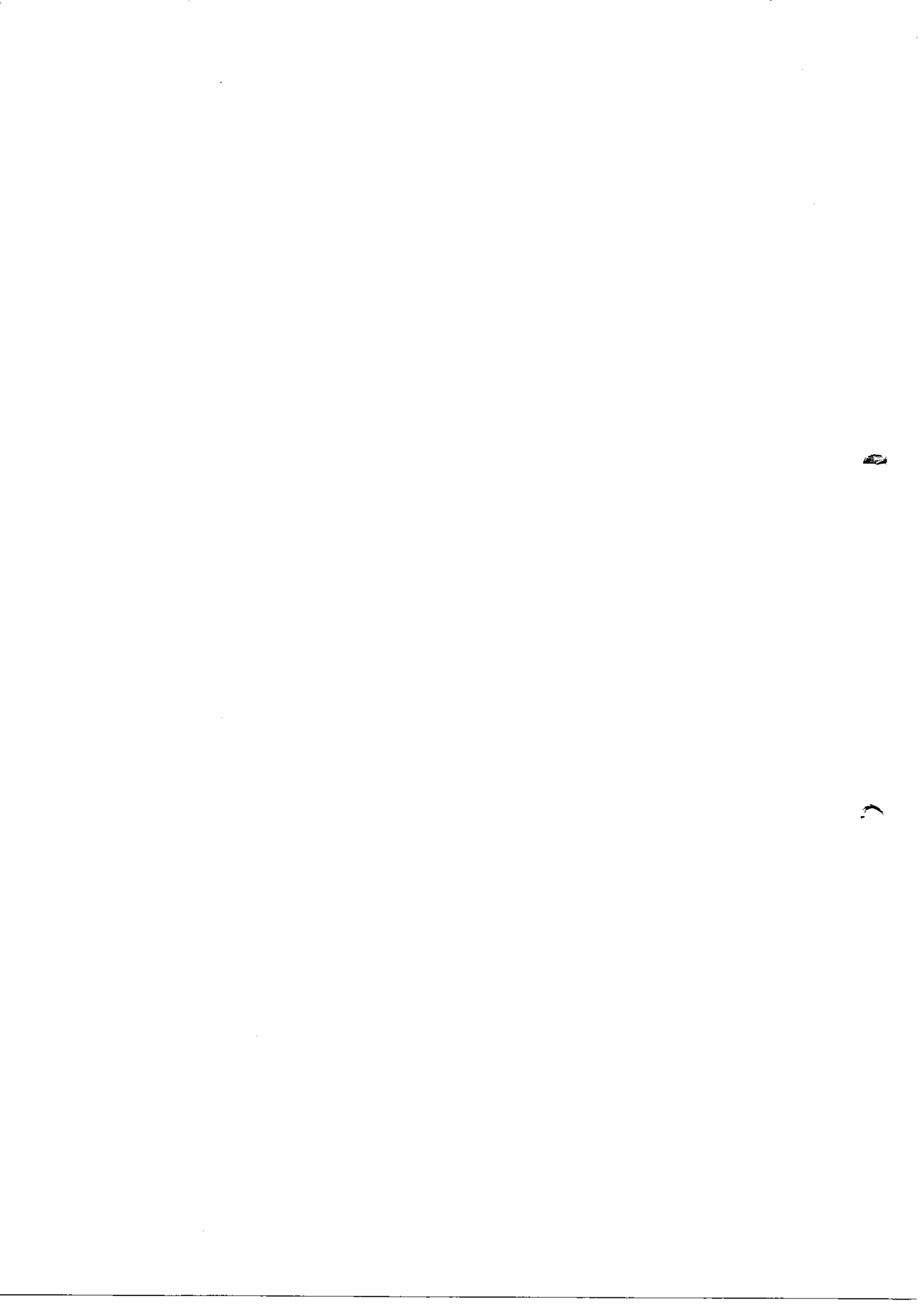

FUEL SYSTEM

SERVICING FUEL SYSTEM

At every 50 hour inspection, the fuel screen in the strainer will require cleaning. The strainer, located ahead of the fire wall, is accessible for cleaning through the left cowl door. After cleaning, a small amount of grease applied to the gasket will facilitate reassembly.

FUEL REQUIREMENTS

The minimum aviation grade fuel for the PA-28-151 is 80/87. Since the use of lower grades can cause serious engine damage in a short period of time, the engine warranty is invalidated by the use of lower octanes.

Whenever 80/87 is not available, the lowest lead 100 grade should be used. (See Fuel Grade Comparison Chart, below)

The continuous use, more than 25% of the operating time, of the higher leaded fuels can result in increased engine deposits, both in the combustion chamber and in the engine oil. It may require increased spark plug maintenance and more frequent oil changes. The frequency of spark plug maintenance and oil drain periods will be governed by the amount of lead per gallon and the type of operation. Operation at full rich mixture requires more frequent maintenance periods; therefore it is important to use proper approved mixture leaning procedures.

Reference Avco Lycoming Service Letter No. L185A attached to the Engine Operators Manual for care, operation and maintenance of the airplane when using the higher leaded fuel.

A summary of the current grades as well as the previous fuel designations are shown in the following chart:

FUEL GRADE COMPARISON CHART

Previous Commercial Fuel Grades (ASTM-D910)			Current Commercial Fuel Grades (ASTM-D910-75)			Current Military Fuel Grades (MIL-G-5572E) Amendment No. 3		
Grade	Color	Max. TEL ml/U.S. gal.	Grade	Color	Max. TEL ml/U.S. gal.	Grade	Color	Max. TEL ml/U.S. gal.
80/87	red	0.5	80	red	0.5	80/87	red	0.5
91/98	blue	2.0	*100LL	blue	2.0	none	none	none
100/130	green	3.0	100	green	**3.0	100/130	green	**3.0
115/145	purple	4.6	none	none	none	115/145	purple	4.6

- * - Grade 100LL fuel in some over seas countries is currently colored green and designated as "100L."
- ** - Commercial fuel grade 100 and grade 100/130 (both of which are colored green) having TEL content of up to 4 ml/U.S. gallon are approved for use in all engines certificated for use with grade 100/130 fuel.

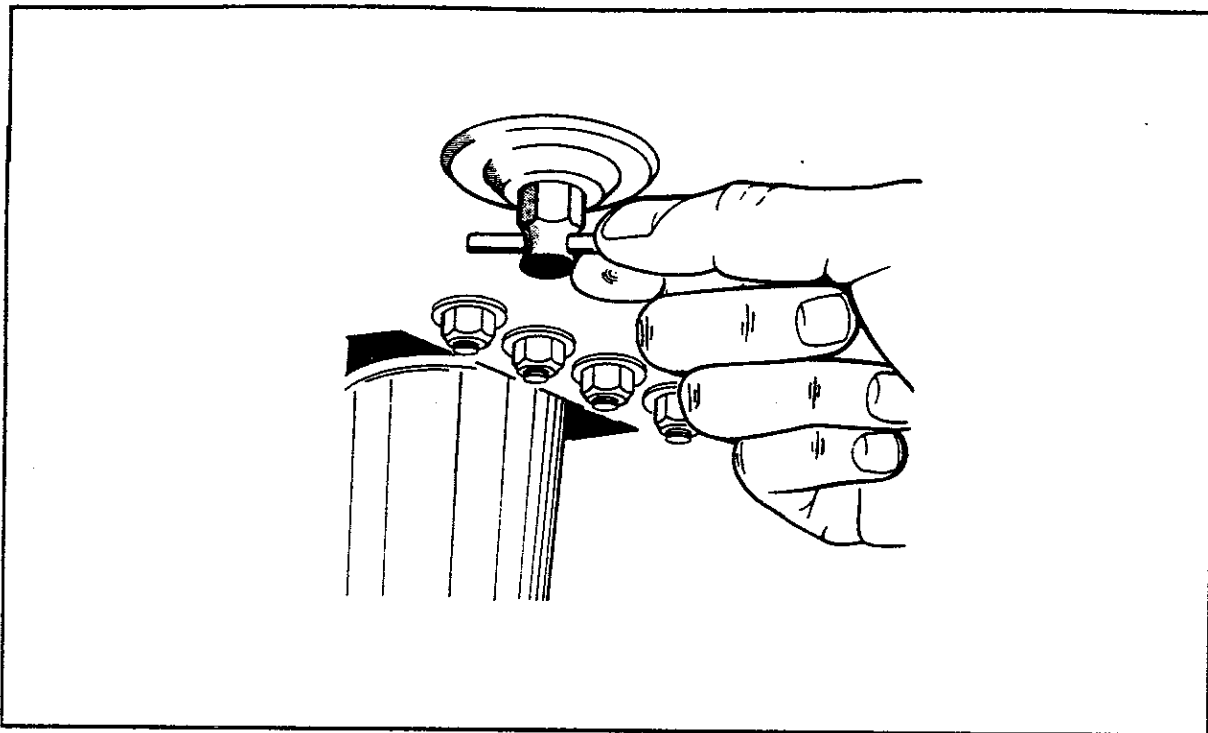

Fuel Drain

FILLING FUEL TANKS

Observe all safety precautions required when handling gasoline. Fuel is stored in two 25 U.S. gallon tanks (24 U.S. gallons usable). To obtain the standard quantity of 50 U.S. gallons (approximately 48 U.S. gallons usable), fill each tank to the top of the filler neck.

DRAINING FUEL VALVES AND LINES

The fuel system should be drained daily prior to first flight and after refueling to avoid the accumulation of water and sediment. Each fuel tank has an individual quick drain at the bottom inboard rear corner, and on early models each fuel collector manifold has a drain under the wing and near the fuselage. Each of these drains should be opened until sufficient fuel has flowed to ensure the removal of any contaminants.

The gascolator, located on the lower left front of the fire wall, is also equipped with a drain. It too should be checked for water or sediment accumulation. The gascolator drain is accessible from outside the nose section of the airplane.

A special bottle is provided for these fuel draining and checking operations.

CAUTION

When draining fuel, be sure that no fire hazard exists before starting the engine.

DRAINING FUEL SYSTEM

The bulk of the fuel may be drained by opening the individual drain on each tank. The remaining fuel in the lines may be drained through the fuel collector manifold drains (on early models only) and the gascolator drain. Any individual tank may be drained through its individual drain.

CAUTION

Whenever the fuel system is completely drained and fuel is replenished it will be necessary to run the engine for a minimum of 3 minutes at 1000 RPM on each tank to insure no air exists in the fuel supply lines.

TIRE INFLATION

For maximum service from the tires, keep them inflated to the proper pressures. The main gear tires should be inflated to 24 psi and the nose gear should be inflated to 30 psi.

Interchange the tires on the main wheels if necessary to produce even wear. All wheels and tires are balanced before original installation, and the relationship of the tire, tube, and wheel should be maintained if at all possible. Unbalanced wheels can cause extreme vibration on takeoff. In the installation of new components, it may be necessary to rebalance the wheel with the tire mounted.

When checking the pressure, examine the tires for wear, cuts, bruises, and slippage.

BATTERY SERVICE

Access to the 12-volt battery is obtained by raising the rear seat and removing the cover of the battery box. The plastic battery box has a drain tube which is normally closed off with a cap and which should be opened occasionally to drain off any accumulation of liquid.

The battery should be checked for proper fluid level. DO NOT fill the battery above the baffle plates. DO NOT fill the battery with acid - use only water. A hydrometer check will determine the percent of charge in the battery.

If the battery is not up to charge, recharge starting at a 4 amp rate and finishing with a 2 amp rate. Quick charges are not recommended.

WINTERIZATION

For winter operation a winterization plate is installed on the inlet opening of the oil cooler. This plate should be installed whenever the ambient temperature reaches 50° F or less. The plate should be removed and stored in the cockpit when the ambient temperature exceeds 50° F.

FACTS YOU SHOULD KNOW

The Federal Aviation Administration (FAA) occasionally publishes **Airworthiness Directives (ADs)** that apply to specific groups of aircraft. They are mandatory changes and are to be complied with within a time limit set by the FAA. When an AD is issued, it is sent by the FAA to the latest registered owner of the affected aircraft and to subscribers of the service. Owners should periodically check with their Piper Service Center or Piper's Customer Services Department to see whether they have the latest AD against their airplane. The owner is solely responsible for keeping up with ADs.

Piper Aircraft Corporation takes a **continuing interest** in having owners get the most efficient use from their airplane and keeping it in the best mechanical condition. Consequently, Piper Aircraft, from time to time, issues Service Bulletins, Service Letters, and Service Spares Letters relating to the airplane.

Service Bulletins are of special importance and Piper considers compliance mandatory. These are sent to the latest FAA-registered owners in the United States (U.S.) and Piper Service Centers worldwide. Depending on the nature of the release, material and labor allowances may apply. This information is provided to all authorized Piper Service Centers.

Service Letters deal with product improvements and service hints pertaining to the airplane. They are sent to Piper Service Centers and, if necessary, the latest FAA-registered owners in the U.S. Owners should give careful attention to Service Letter information.

Service Spares Letters offer improved parts, kits, and optional equipment which were not available originally, and which may be of interest to the owner.

Piper Aircraft Corporation offers a **subscription service** for Service Bulletins, Service Letters, and Service Spares Letters. This service is available to interested persons, such as owners, pilots, and mechanics at a nominal fee, and may be obtained through a Piper Service Center or Piper's Customer Services Department.

A maintenance manual, parts catalog, and revisions to both, are available from Piper Service Centers or Piper's Customer Services Department. Any correspondence regarding the airplane should include the airplane model and serial number to ensure proper response.

Pilot's Operating Manual supplements are distributed by the manufacturer as necessary. These revisions and additions should be studied and put into the operating manual to keep it up to date. This manual contains important information about the operation of the aircraft and should be kept with the airplane at all times, even after resale. Every owner, to avail themselves of the latest information concerning their airplane, should stay in contact with their Piper Service Center or Piper's Customer Services Department.

The owner or pilot is required to ascertain that the following Aircraft Papers are in order and in the aircraft.

- a. To be displayed in the aircraft at all times:
 1. Aircraft Airworthiness Certificate Form FAA-1362B.
 2. Aircraft Registration Certificate Form FAA-500A.
 3. Aircraft Radio Station License Form FCC-404A, if transmitters are installed.
- b. To be carried in the aircraft at all times:
 1. Aircraft Flight Manual.
 2. Weight and Balance data plus a copy of the latest Repair and Alteration Form FAA-337, if applicable.
 3. Aircraft equipment list.

Although the aircraft and engine log books are not required to be in the aircraft, they should be made available upon request. Log books should be complete and up to date. Good records will reduce maintenance cost by giving the mechanic information about what has or has not been accomplished.

PREVENTIVE MAINTENANCE

The holder of a Pilot Certificate issued under FAR Part 61 may perform certain preventive maintenance described in FAR Part 43. This maintenance may be performed only on an aircraft which the pilot owns or operates and which is not used in air carrier service. The following is a list of the maintenance which the pilot may perform:

1. Repair or change tires and tubes.
2. Service landing gear wheel bearings, such as cleaning, greasing or replacing.
3. Service landing gear shock struts by adding air, oil or both.
4. Replace defective safety wire and cotter keys.
5. Lubrication not requiring disassembly other than removal of non-structural items such as cover plates, cowling or fairings.
6. Replenish hydraulic fluid in the hydraulic reservoirs.
7. Refinish the exterior or interior of the aircraft (excluding balanced control surfaces) when removal or disassembly of any primary structure or operating system is not required.
8. Replace side windows and safety belts.
9. Replace seats or seat parts with replacement parts approved for the aircraft.
10. Replace bulbs, reflectors and lenses of position and landing lights.
11. Replace cowling not requiring removal of the propeller.
12. Replace, clean or set spark plug clearance.
13. Replace any hose connection, except hydraulic connections, with replacement hoses.
14. Replace pre-fabricated fuel lines.
15. Replace the battery and check fluid level and specific gravity.

Although the above work is allowed by law, each individual should make a self analysis as to whether he has the ability to perform the work.

If the above work is accomplished, an entry must be made in the appropriate log book. The entry should contain:

1. The date the work was accomplished.
2. Description of the work.
3. Number of hours on the aircraft.
4. The certificate number of pilot performing the work.
5. Signature of the individual doing the work.

REQUIRED SERVICE AND INSPECTION PERIODS

Piper Aircraft Corporation provides for the initial and first 50-hour inspection, at no charge to the owner. The **Owner Service Agreement** which the owner receives upon delivery of the aircraft should be kept in the aircraft at all times. This identifies him to authorized Piper dealers and entitles the owner to receive service in accordance with the regular service agreement terms. This agreement also entitles the transient owner full warranty by any Piper dealer in the world.

One hundred hour inspections are required by law if the aircraft is used commercially. Otherwise this inspection is left to the discretion of the owner. This inspection is a complete check of the aircraft and its systems, and should be accomplished by a Piper Authorized Service Center or by a qualified aircraft and power plant mechanic who owns or works for a reputable repair shop. The inspection is listed, in detail, in the inspection report of the appropriate Service Manual.

An annual inspection is required once a year to keep the Airworthiness Certificate in effect. It is the same as a 100-hour inspection except that it must be signed by an Inspection Authorized (IA) mechanic or a General Aviation District Office (GADO) representative. This inspection is required whether the aircraft is operated commercially or for pleasure.

A Progressive Maintenance program is approved by the FAA and is available to the owner. It involves routine and detailed inspections at 50-hour intervals. The purpose of the program is to allow maximum utilization of the aircraft, to reduce maintenance inspection cost and to maintain a maximum standard of continuous airworthiness. Complete details are available from Piper dealers.

A spectographic analysis of the oil is available from several sources. This system, if used intelligently, provides a good check of the internal condition of the engine. For this system to be accurate, oil samples must be sent in at regular intervals, and induction air filters must be cleaned or changed regularly.

TYPE OF LUBRICANT		
IDENTIFICATION LETTER	LUBRICANT	PREFERRED PRODUCT AND VENDOR
A	LUBRICATING OIL, GENERAL PURPOSE, LOW TEMP.	MIL L-7870
B	LUBRICATING OIL, AIRCRAFT RECIPROCATING ENGINE (PISTON) GRADE AS SPECIFIED SAE 50 ABOVE 80°F AIR TEMP. SAE 40 30° TO 80°F AIR TEMP. SAE 30 0° TO 70°F AIR TEMP. SAE 20 BELOW 10°F AIR TEMP.	MIL L-6882
C	HYDRAULIC FLUID, PETROLEUM BASE.	MIL-H-5606
D	GREASE, AIRCRAFT AND INSTRUMENT, GEAR AND ACTUATOR SCREW.	MIL-G-23827
E	GREASE, AIRCRAFT, HIGH TEMP.	TEXACO MARFAK ALL PURPOSE GREASE, MOBIL GREASE 77 (OR MOBILUX EP2), SHELL ALVANIA EP GREASE 2
F	PARKER "O" RING LUBRICANT	FISKE BROS. REFINING CO.
G	AERO LUBRIPLATE	*MS-122
H	FLUOROCARBON RELEASE AGENT DRY LUBRICANT	MIL-G-7711
I	GREASE, LUBRICATION GEN. PURPOSE AIRCRAFT	

NOTES

1. PILOT AND PASSENGER SEATS - LUBRICATE TRACK ROLLERS AND STOP PINS AS REQUIRED. (TYPE OF LUBRICANT: "A")
2. WHEEL BEARINGS - REQUIRE CLEANING AND REPACKING AFTER EXPOSURE TO AN ABNORMAL QUANTITY OF WATER.
3. FUEL SELECTOR VALVE - LUBRICATE FUEL SELECTOR VALVE AS REQUIRED. REFER TO PIPER SERVICE LETTER NO. 351.
4. SEE LYCOMING SERVICE INSTRUCTIONS NO. 1014 FOR USE OF DETERGENT OIL.

CAUTIONS

1. DO NOT USE HYDRAULIC FLUID WITH A CASTOR OIL OR ESTER BASE.
2. DO NOT OVER-LUBRICATE COCKPIT CONTROLS.
3. DO NOT APPLY LUBRICANT TO RUBBER PARTS.

EXAMPLE

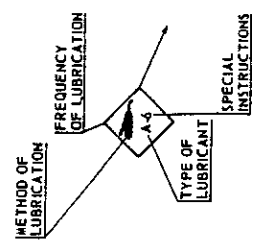

SPECIAL INSTRUCTIONS

1. AIR FILTER - TO CLEAN FILTER, TAP GENTLY TO REMOVE DIRT PARTICLES. DO NOT BLOW OUT WITH COMPRESSED AIR OR USE OIL. REPLACE FILTER IF PUNCTURED OR DAMAGED.
2. BEARINGS AND BUSHINGS - CLEAN EXTERIOR WITH A DRY TYPE SOLVENT BEFORE LUBRICATING.
3. WHEEL BEARINGS - DISASSEMBLE AND CLEAN WITH A DRY TYPE SOLVENT. ASCERTAIN THAT GREASE IS PACKED BETWEEN THE BEARING ROLLER AND CONE. DO NOT PACK GREASE IN WHEEL HOUSING.
4. OLEO STRUTS, AND BRAKE RESERVOIR - FILL PER INSTRUCTIONS ON UNIT OR CONTAINER, OR REFER TO SERVICE MANUAL, SECTION II.
5. "O" RING, CONTROL SHAFT BUSHING (WITH 1.125 INCH SHAFT ONLY) - DISASSEMBLE "O" RING, RETAINER PLATES FROM INSTRUMENT PANEL, LUBRICATE "O" RING AND REASSEMBLE.
6. LUBRICATION POINTS - WIPE ALL LUBRICATION POINTS CLEAN OF OLD GREASE, OIL, DIRT, ETC. BEFORE LUBRICATING.
7. INTERVALS BETWEEN OIL CHANGES CAN BE INCREASED AS MUCH AS 100% ON ENGINES EQUIPPED WITH FULL FLOW (CARTRIDGE TYPE) OIL FILTERS. PROVIDED THE ELEMENT IS REPLACED EACH 50 HOURS OF OPERATION AND THE SPECIFIED OCTANE FUEL IS USED. SHOULD FUEL OTHER THAN THE SPECIFIED OCTANE RATING FOR THE POWER PLANT BE USED, REFER TO LYCOMING SERVICE LETTER NO. L185A FOR ADDITIONAL INFORMATION AND RECOMMENDED SERVICE PROCEDURES.

Lubrication Nomenclature

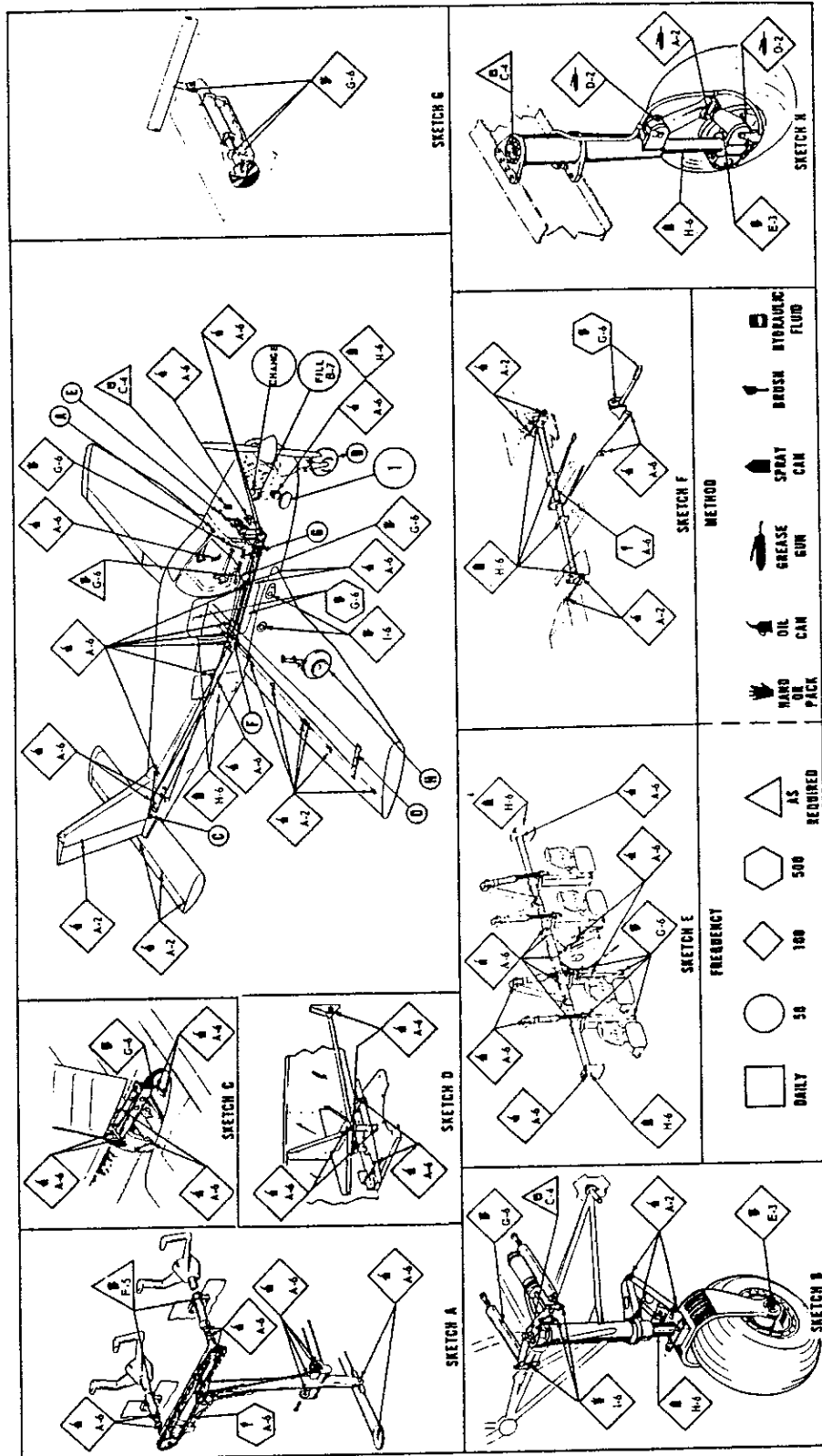

Lubrication Chart

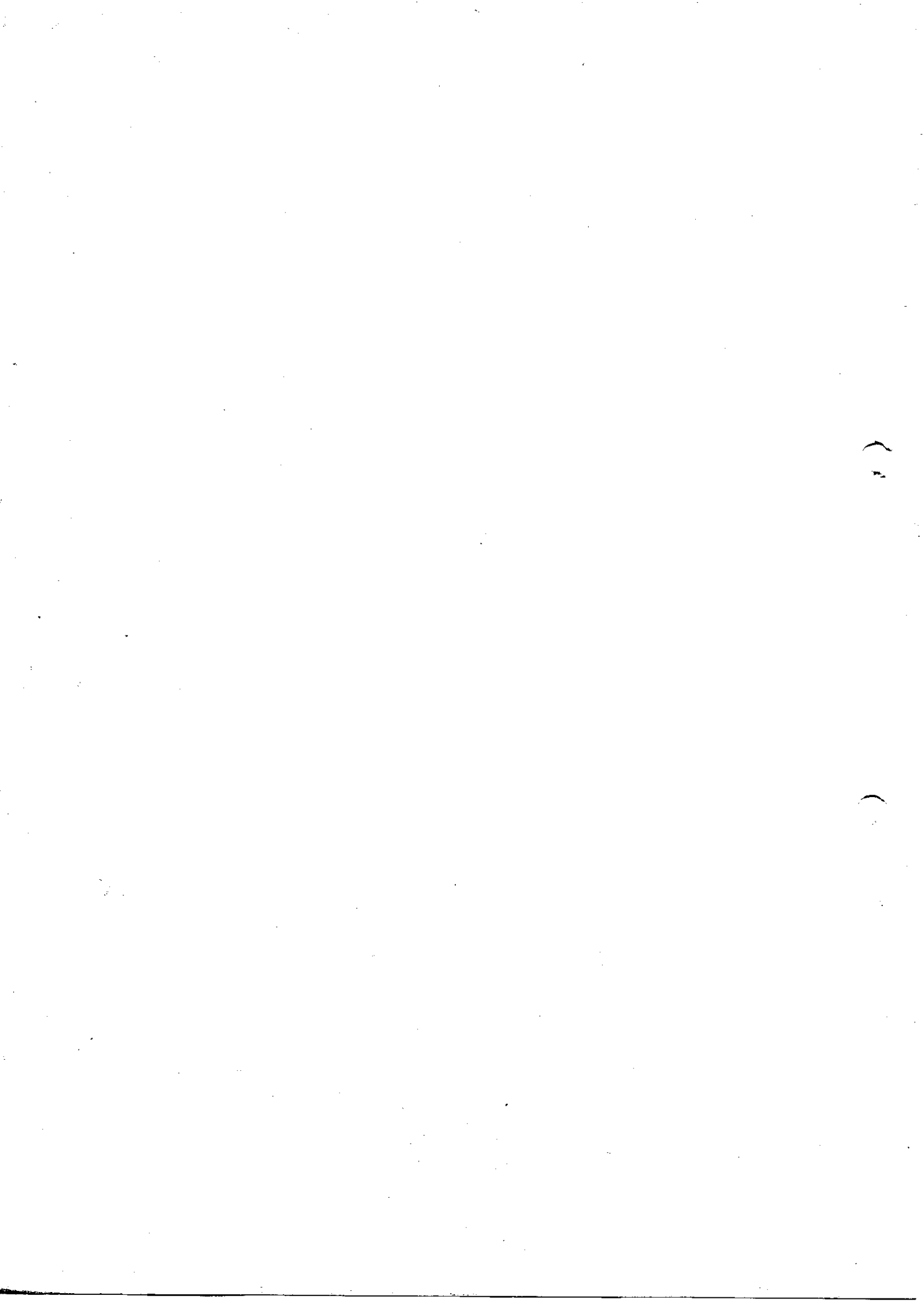

INDEX of ADDITIONAL SUPPLEMENTS

for

PILOT'S OPERATING HANDBOOK
Part Number: 761 563

for OE -DHU
Piper PA-28-151 Cherokee Warrior

Becker Audio Selector Panel AL3	see Pilots Guide	removed
TY 96	see Pilots Guide	✓
1. TT 31	see Pilots Guide	✓
Becker NAV 2000	see Pilots Guide	removed
DME KN 62A	see Pilots Guide	removed
ADF 300	see Pilots Guide	removed
2. ELT 406 AF Compact	see Pilots Guide	—
3. Altitude Digitizer ACK A30	see Pilots Guide	✓
4. Total Hal 1.0 Fire Extinguisher	see Pilots Guide	—
15. Petersen Aviation Inc.	— u —	✓
6. Garmin GNC 255A		
7. Garmin GTN 650Xi		
8. Air Avionics AT-1		
9. Garmin G5		
10. Gromelzig Nachschalldämpfer		

(

(

(

(

(

TRIG

TT31 Mode S Transponder Operating Manual



00454-00-AF
18 April 2017

Trig Avionics Limited
Heriot Watt Research Park
Riccarton, Currie
EH14 4AP
Scotland, UK

© Copyright 2011

EN / DE / FR

1

2

3

4

5

Front Panel

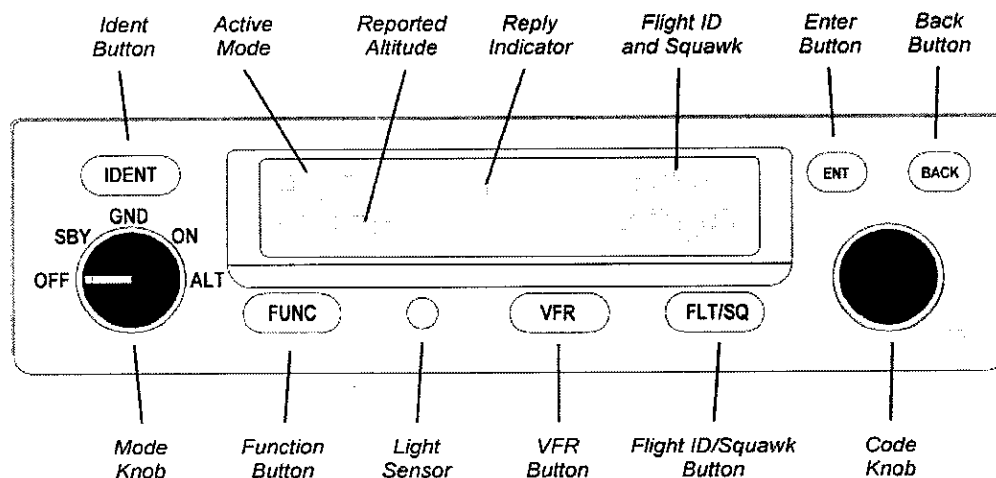

Display

The display shows the operating mode of the transponder, the reported pressure altitude, and the current squawk code and Flight ID. The reply indicator is active when the transponder replies to interrogations.

The pressure altitude is displayed as a Flight Level, which is the pressure altitude in hundreds of feet. When non-standard atmospheric conditions apply, this may not match the altimeter indicated altitude, but will be correctly displayed by the ATC radar.

Mode Selector Knob

The left hand knob controls the power to the transponder and the operating mode.

- OFF Power is removed from the transponder.
- SBY The transponder is on, but will not reply to any interrogations.
- GND The transponder will respond to Mode S ground interrogations from surface movement radar.
- ON The transponder will respond to all interrogations, but altitude reporting is suppressed.
- ALT The transponder will respond to all interrogations.

When airborne, the transponder should always be set to ALT unless otherwise directed by Air Traffic Control. When you are taxiing on the ground, the transponder should be set to GND mode. If your installation includes a squat switch or is configured with an automatic air/ground system it will switch automatically and you do not need to manually select the GND position.

EN

Push Buttons

- IDENT** Press the IDENT button when ATC instructs you to "Ident" or "Squawk Ident". This activates the SPI pulse in the transponder replies for 18 seconds. IDENT will appear in the display.
- FUNC** Pressing the FUNC button provides access to the flight timer, stopwatch, ADS-B monitor (depending on installation) and altitude monitor function.
- VFR** Pressing the VFR button sets the transponder to the pre-programmed conspicuity code. Pressing the button again restores the previous squawk code.
- FLT/SQ** Pressing FLT/SQ alternates the primary display between squawk code and Flight ID.
- ENT** The ENT button enters a digit in the code selector.
- BACK** The BACK button goes back to the previous digit in the code selector.

Code Selector Knob

The right hand knob is used to set squawk codes and the Flight ID. The FLT/SQ button selects which will be updated. Turning the knob will highlight the first digit on the display, and the digit can be changed as required. Press the ENT button to advance to the next digit. When ENT is pressed on the last digit, the new squawk code or Flight ID will replace the previous value. If the code entry is not completed within 7 seconds, the changes are ignored and the previous code restored.

1200	VFR code in the USA
7000	VFR code commonly used in Europe
7500	Hijack code
7600	Loss of communications
7700	Emergency code

The Flight ID should correspond to the aircraft call sign entered on your flight plan. If no flight plan is active, the aircraft registration should be used as your Flight ID. Use only letters and digits. If the Flight ID is less than 8 characters long, entering a blank character will end it.

Flight Timer

The Flight Timer records the time for which the transponder has been powered on and operating in flight mode – either ON or ALT. Press the FUNC button to display the Flight Timer.

Stopwatch

The stopwatch can be used as a convenient timer. Press the FUNC button to display the stopwatch. Pressing ENT will reset and start the timer. Pressing ENT again will stop the timer.

Altitude Monitor

The Altitude Monitor activates an audio annunciator or annunciator light (depending on installation) when the aircraft pressure altitude differs from the selected altitude by more than 200 feet. Press the FUNC button to display the altitude monitor enable screen. Pressing ENT toggles the altitude monitor at the current altitude.

When altitude monitoring is in use, a small deviation pointer appears adjacent to the altitude display on the transponder.

ADS-B Monitor

The ADS-B Monitor is only available on installations that include an ADS-B position source. The ADS-B Monitor provides a display of the position information that is being transmitted in ADS-B position reports. This can provide confirmation that the correct information is being transmitted, particularly where the GPS source is remote from the transponder.

In the event that valid position information is NOT available from the GPS, the latitude and longitude display will be replaced by dashes; if no valid latitude and longitude is shown then ADS-B position information is NOT being transmitted.

Loss of ADS-B position information will also result in a WARNING message being displayed.

Warning Messages

If the transponder detects a problem, the screen will indicate WARNING and a brief statement of the problem. Depending on the nature of the problem, your transponder may not be replying to interrogations. Note the message on the screen and pass that information to your avionics maintenance organisation. Press ENT to clear the message; if the fault is still present the message will reappear.

Fault Annunciation

If the transponder detects an internal failure, the screen will indicate FAULT and a brief statement of the problem. No replies will be made to interrogations when a fault is detected.

Some FAULT indications can be recovered by switching the transponder off and back on again, although in all cases a FAULT code implies that there is a fault with the transponder or the installation. Note the FAULT message at the

bottom of the screen and pass that information to your avionics maintenance organisation.

Configuration Mode

The system is configured when it is first installed by your avionics supplier. Configuration items include the Mode S aircraft address, the interface to the other aircraft systems, the aircraft category, and the pre-programmed values for VFR squawk code. To view or change these settings you must use Configuration Mode.

Do not use Configuration Mode in flight. Check with your avionics installer before changing the configuration.

To enter configuration mode, hold down the FUNC button whilst switching on the transponder. Configuration items can be changed using the Code Knob and the ENT and BACK buttons. Pressing FUNC advances to the next configuration item.

When configuration is complete, switch the transponder off. When it is switched back on the transponder will use the new configuration.

Low Temperature Operation

The TT31 is certified to operate correctly down to -20C, but at low temperatures the display may be impaired. On a cold day you may need to wait for the cockpit to warm up to ensure normal operation.

Gerätefront

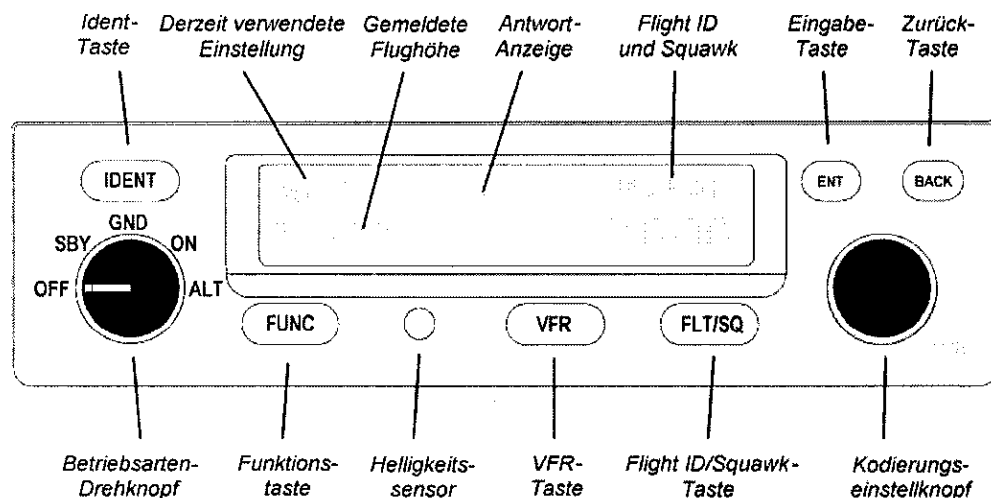

Anzeige

Die Anzeige gibt folgendes wieder: Betriebsart des Transponders, die gemeldete Druckhöhe, sowie den derzeitigen Squawk Code und Flight ID. Die „Reply“-Anzeige ist aktiv, wenn das Gerät auf Anfragen antwortet.

Die Druckhöhe wird als Flugfläche (FL) angezeigt, d.h. als Druckhöhe in Schritten von 100 Fuß. Wenn die Wetterlage von der Standardatmosphäre abweicht, kann die Anzeige u.U. von der des Höhenmessers abweichen, wird aber vom ATC Radar korrekt wiedergegeben.

Betriebsarten-Drehknopf

Der linke Drehknopf regelt die Stromversorgung zum Transponder sowie die Betriebsart.

- OFF Die Stromzufuhr zum Transponder ist unterbrochen.
- SBY Der Transponder ist eingeschaltet, antwortet aber nicht auf Anfragen.
- GND Der Transponder antwortet auf Mode-S-Anfragen des Vorfeld-Radars.
- ON Der Transponder antwortet auf alle Anfragen, aber ohne Höhenübermittlung.
- ALT Der Transponder antwortet auf alle Anfragen.

Im Fluge sollte der Transponder stets auf „ALT“ eingestellt sein, außer wenn die Flugsicherung dies über Funk anders fordert. Beim Rollen am Boden sollte der Transponder stets auf "GND" eingestellt sein. Wenn Sie einen Bodensicherheitsschalter einbauen wollen, der mit einem automatischen

Bord/Boden System konfiguriert ist, wird er sich automatisch auf "GND" schalten lassen, sodass Sie es nicht von Hand machen müssen.

Drucktasten

- IDENT** Drücken Sie die „IDENT“-Taste, wenn die Flugsicherung Sie zum „Ident“ oder „Squawk Ident“ auffordert. Dies aktiviert den SPI-Puls in den Antworten des Transponders für 18 Sekunden. Die Funktion IDENT wird in der Anzeige des Gerätes wiedergegeben.
- FUNC** Durch Drücken der „FUNC“-Taste gelangen Sie zu den Funktionen der Flugzeitmessung, Stoppuhr, ADS-B Monitor (in Abhängigkeit der Ausrüstung) und Flughöhenüberwachung.
- VFR** Ein Druck auf die „VFR“-Taste aktiviert den vorprogrammierten Code. Ein weiterer Tastendruck reaktiviert den vorherigen Squawk-Code.
- FLT/SQ** Mit der Taste „FLT/SQ“ können Sie zwischen der Anzeige des Squawk-Codes und der Flight ID wechseln.
- ENT** Mit der „ENT“-Taste können Sie einzelne Zahlen eingeben.
- BACK** Durch Drücken der Taste „BACK“ können Sie bei Eingabe des Codes eine Stelle zurückgehen.

Kodierungseinstellknopf

Der rechte Drehknopf wird zur Einstellung von Squawk-Codes und Flight IDs benutzt. Mit der „FLT/SQ“-Taste wird die jeweils zu ändernde Funktion gewählt. Ein Drehen des Knopfes aktiviert die erste Stelle der Anzeige, die dann nach Bedarf geändert werden kann. Per „ENT“-Taste gelangt man zur jeweils nächsten Stelle. Wenn bei der letzten Stelle „ENT“ gedrückt wird, ersetzt der neue Squawk-Code oder die neue Flight ID die zuvor genutzten Zahlen. Wenn eine Zahl nicht innerhalb von 7 Sekunden verändert wird, werden die bisherigen Änderungen vom Gerät ignoriert, und die vorherige Zahlenkombination wird wieder hergestellt.

1200	VFR code in den USA
7000	Am häufigsten in Europa genutzter VFR-Code
7500	Code für Entführungen
7600	Funkausfall
7700	Notfall

Die Flight ID sollte dem Rufzeichen entsprechen, das Sie im Flugplan eingetragen haben. Wenn Sie keinen Flugplan erstellt haben, sollte das Kennzeichen des Lfz als Flight ID genutzt werden. Benutzen Sie nur Buchstaben und Zahlen. Wenn die Flight ID kürzer als acht Stellen ist, geben Sie eine Leerstelle als Endzeichen ein.

Flugzeitmessung

Der Flugzeitmesser zeichnet die Zeit auf, seitdem die Stromzufuhr zum Transponder eingeschaltet und eine der Flugeinstellungen, d.h. „ON“ oder „ALT“, aktiviert wurde. Durch Drücken der „FUNC“-Taste können Sie die Flugzeit anzeigen lassen.

Stoppuhr

Die Stoppuhr kann ebenfalls zur Zeitmessung genutzt werden. Drücken Sie die „FUNC“-Taste, um die Stoppuhr aufzurufen. Ein Druck auf „ENT“ wird die Stoppuhr auf 0 setzen und neu starten. Ein weiterer Druck auf „ENT“ hält die Zeitmessung an.

Flughöhenüberwachung

Die Flughöhenüberwachung aktiviert ein akustisches oder optisches Warnsignal (in Abhängigkeit der Ausrüstung), wenn die Flughöhe mehr als 200 Fuß von der zuvor eingestellten Angabe abweicht. Drücken Sie die „FUNC“-Taste bis zum Erreichen der Anzeige zur Aktivierung der Funktion „Altitude Monitor“. Per „ENT“-Taste programmieren Sie Ihre aktuelle Flughöhe als Ausgangswert.

Wenn diese Funktion eingeschaltet ist, erscheint neben der Höhenangabe die kleine Abweichungsanzeige nach oben oder unten.

ADS-B Monitor

Diese Funktion kann nur genutzt werden, wenn das Lfz zur Positionsbestimmung für ADS-B ausgerüstet ist. Der ADS-B Monitor zeigt die Position basierend auf Daten, die durch ADS-B-Positionsmeldungen übermittelt werden. Dies kann zur Bestätigung der Richtigkeit der übertragenen Positionsinformationen dienen, insbesondere, wenn der GPS-Empfang sehr schwach ist.

Falls eine zuverlässigen Positionsangabe durch das GPS NICHT möglich ist, werden die Längen- und Breitengrade als Horizontalstriche angezeigt. Wenn dies der Fall ist, werden ADS-B-Positionsinformationen NICHT übermittelt.

Warnmeldungen

Falls eine Störung auftritt, meldet der Transponder dies sofort. Die Anzeige WARNING leuchtet auf; zusätzlich wird eine kurze Beschreibung des Problems angezeigt. Es ist nun von der Art des Problems abhängig, ob der Transponder weiterhin auf Anfragen antwortet. Übermitteln Sie diese Fehlermeldung an Ihren Avionik-Betrieb. Drücken Sie ENT, und die Fehlermeldung erlischt. Falls das Problem weiterhin besteht, wird der Transponder dies entsprechend melden.

Fehlermeldung

Wenn der Transponder einen internen Fehler feststellt, wird dies in der Anzeige durch „FAULT“ plus einer kurzen Problembeschreibung gemeldet. Sobald ein Fehler festgestellt wurde, antwortet der Transponder nicht mehr auf Anfragen durch die Flugsicherung.

Einige „FAULT“-Anzeigen können durch Aus- und Einschalten des Transponders behoben werden, jedoch bedeutet jede Anzeige dieser Art, dass ein Fehler im Gerät oder der Installation vorliegt. Melden Sie die vom Gerät entsprechend gegebene Problembeschreibung zur Behebung an Ihren Avionik-Betrieb.

Einstellung „Konfiguration“

Das Gerät ist zum Zeitpunkt des Einbaus durch Ihren Avionik-Zulieferer konfiguriert. Die Konfiguration beinhaltet den Mode-S-Code, das Interface zu anderen Geräten, die Lfz-Kategorie, und die vorprogrammierten Werte für VFR Squawk Codes. Um diese Einstellungen zu sehen oder zu ändern müssen Sie die Einstellung „Konfiguration“ benutzen.

Benutzen Sie die Einstellung „Konfiguration“ niemals im Fluge.

Setzen Sie sich mit Ihrem Avionik-Betrieb in Verbindung, bevor Sie die Konfiguration verändern.

Um zur Einstellung „Konfiguration“ zu gelangen, halten Sie die Taste „FUNC“ gedrückt, während Sie das Gerät einschalten. Konfigurationspunkte können durch Drehen des Kodierungsdrehknopfes und durch Drücken der Tasten „ENT“ und „BACK“ verändert werden. Nach Abschluss der Konfiguration schalten Sie den Transponder aus. Sobald er erneut eingeschaltet wird, benutzt er die neue Konfiguration.

Betrieb bei niedriger Temperatur

Der TT31 ist zugelassen für fehlerfreien Betrieb bis zu -20°C , auch wenn bei sehr niedrigen Temperaturen u.U. die Anzeigequalität vermindert ist. Um die normale Benutzung unter kalten Bedingungen sicherzustellen, ist es ggf. erforderlich, eine adäquate Kabinentemperatur zu erzeugen.

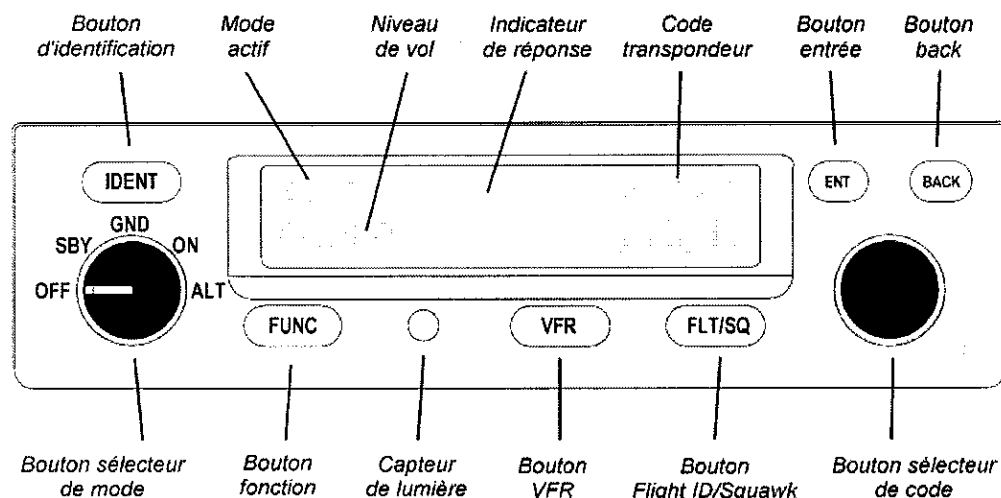

Panneau

Affichage

L'écran affiche le mode de fonctionnement du transpondeur, l'altitude-pression mesurée, ainsi que le code transpondeur et le code d'identification de vol en cours. L'indicateur de réponse est actif lorsque le transpondeur répond aux interrogations.

L'altitude-pression s'affiche en niveau de vol, c'est à dire l'altitude-pression en centaines de pieds. Lorsque les conditions atmosphériques ne sont pas standards, cette valeur peut être différente de l'altitude indiquée par l'altimètre, mais son affichage sera correct sur les écrans radar du contrôle de la circulation aérienne.

Bouton Sélecteur de Mode

Le bouton de gauche commande la mise sous tension du transpondeur ainsi que le mode de fonctionnement.

- OFF Le transpondeur est hors tension.
- SBY Le transpondeur est sous tension mais ne répondra à aucune interrogation.
- GND Le transpondeur répondra aux interrogations du sol en Mode S des radars de mouvement à la surface.
- ON Le transpondeur répondra à toutes les interrogations, mais sans information d'altitude.
- ALT Le transpondeur répondra à toutes les interrogations.

En vol, le transpondeur doit toujours être sur ALT sauf avis contraire du contrôle de la circulation aérienne. Lorsque l'appareil roule au sol, le transpondeur doit être sur GND. Si l'installation comprend un contact de train ou dispose d'un système de détection automatique air/ground alors la

sélection GND changera automatiquement, vous n'aurez pas besoin de le faire manuellement.

Boutons Poussoirs

- IDENT** Appuyer sur IDT lorsque le contrôle de la circulation aérienne demande « Ident » ou « Squawk Ident ». Ceci active l'impulsion spéciale d'identification de position (SPI) dans les réponses du transpondeur pendant 18 secondes. IDENT apparaîtra à l'écran.
- FUNC** Appuyer sur le bouton FUNC permet d'accéder au temporisateur de vol, au chronomètre, au moniteur d'ADS-B (selon l'installation) et à la fonction de moniteur d'altitude.
- VFR** Une pression sur le bouton VFR permet d'afficher directement le code pré-programmé. Une seconde pression sur ce bouton restaure le code transpondeur précédent.
- FLT/SQ** La pression de FLT/SQ alterne l'affichage primaire entre le squawk code et l'identification de vol.
- ENT** Le bouton ENT permet de valider chaque chiffre dans le sélecteur de code.
- BACK** Le bouton BACK saute de nouveau au chiffre précédent dans le sélecteur de code.

Bouton Sélecteur

Le bouton de droite permet d'afficher le code transpondeur et le code d'identification de vol. Le bouton FLT/SQ choisit qui sera mis à jour. La rotation du bouton accentuera le premier chiffre sur l'affichage, et le chiffre peut être changé comme exigé. Appuyer sur ENT pour avancer au chiffre suivant. Lorsque le bouton ENT est enfoncé après le dernier chiffre, le nouveau code transpondeur ou le nouveau code d'identification de vol s'affiche en remplacement du précédent. Si le code n'est pas saisi en moins de 7 secondes, les modifications sont ignorées et le code précédent est restauré.

1200	Code VFR aux Etats-Unis
7000	Code VFR couramment utilisé en Europe
7500	Intervention illicite
7600	Panne radio
7700	Code de détresse

Le code d'identification de vol doit correspondre à numéro de vol déclaré dans le plan de vol. S'il n'y a pas de plan de vol, l'immatriculation de l'avion doit être utilisée comme code d'identification de vol. Utiliser uniquement des lettres et des chiffres. Si le code d'identification de vol comporte moins de 8 caractères, saisir un caractère espace pour le terminer.

Temporisateur de Vol

Le temporisateur de vol enregistre le temps l'où le transpondeur a été mis sous tension et actionnant en vol le mode ON ou ALT. Appuyez sur le bouton FUNC pour montrer le temporisateur de vol.

Chronomètre

Le chronomètre peut être employé comme temporisateur commode. Appuyez sur le bouton FUNC pour montrer le chronomètre. En serrant la volonté ENT remettez à zéro et commencez le temporisateur. La pression ENT encore arrêtera le temporisateur.

Moniteur D'Altitude

Le moniteur d'altitude active un annonceur ou une lumière audio d'annonceur (selon l'installation) quand l'altitude pression d'avion diffère de l'altitude choisie par plus de 200 pieds. Appuyez sur le bouton FUNC pour montrer le moniteur d'altitude permettent l'écran. Serrant les cabillots ENT l'altitude surveillent à l'altitude courante.

Quand la surveillance d'altitude est en service, un petit indicateur de déviation apparaît à côté de l'affichage d'altitude sur le transpondeur.

Moniteur ADS-B

Le moniteur d'ADS-B est seulement disponible sur les installations qui incluent une source de position d'ADS-B. Le moniteur d'ADS-B fournit un affichage d'information de position qui est transmise dans des rapports de position d'ADS-B. Ceci peut fournir la confirmation que l'information correcte est transmise, en particulier où la source de GPS est éloignée du transpondeur.

Au cas où l'information valide de position ne serait pas fournie par le GPS, l'affichage de latitude et de longitude sera remplacé par des tirets; si aucune latitude et longitude valides n'est montrée alors l'information de position d'ADS-B n'est pas transmise.

Messages d'avertissement

Si le transpondeur détecte un problème, l'écran affichera WARNING ainsi qu'un bref état de la situation. En fonction de la nature du problème, il se peut que le transpondeur ne réponde plus aux interrogations. Noter le message qui apparaît à l'écran et transmettre l'information au service de maintenance du fournisseur d'avionique. Appuyer sur ENT pour effacer le message; si la panne est toujours présente, le message réapparaîtra.

Annonce de Panne

Si le transpondeur détecte une panne interne grave, un message FAULT apparaît à l'écran avec un bref état de la situation. Le transpondeur ne répond plus aux interrogations lorsqu'une panne est détectée.

Certaines indications de pannes (FAULT) peuvent être rétablies en mettant le transpondeur hors tension puis à nouveau sous tension, bien que dans tous les cas, un message FAULT indique un problème avec le transpondeur ou avec l'installation. Noter le message FAULT en bas de l'écran et transmettre l'information au service de maintenance du fournisseur d'électronique aéronautique.

Mode Configuration

Le système est configuré lors de sa première installation par le fournisseur d'avionique. Les éléments de configuration comprennent l'adresse Mode S de l'avion, l'interface avec les autres systèmes de l'avion, la catégorie de l'avion, et les valeurs pré-programmées du code transpondeur VFR. Pour visualiser ou modifier ces réglages, le mode configuration doit être utilisé.

Ne pas utiliser le mode configuration en vol. Consulter votre installateur d'avionique avant toute modification de la configuration.

Pour passer en mode configuration, maintenir le bouton FN enfoncé tout en mettant sous tension du transpondeur. Les éléments de configuration peuvent être modifiés à l'aide du bouton sélecteur de code et les boutons ENT et BACK. Une pression sur FN permet d'avancer jusqu'à l'élément de configuration suivant.

Lorsque la configuration est terminée, mettre le transpondeur hors tension. Lorsqu'il sera de nouveau mis sous tension, le transpondeur utilisera la nouvelle configuration.

Opération à Basses Températures

Le transpondeur est certifié pour fonctionner correctement jusqu'à -20°C , mais à ces températures, l'affichage peut s'en trouver affecté. S'il fait froid, un temps d'attente jusqu'à ce que le cockpit soit réchauffé peut être nécessaire pour garantir un fonctionnement normal.

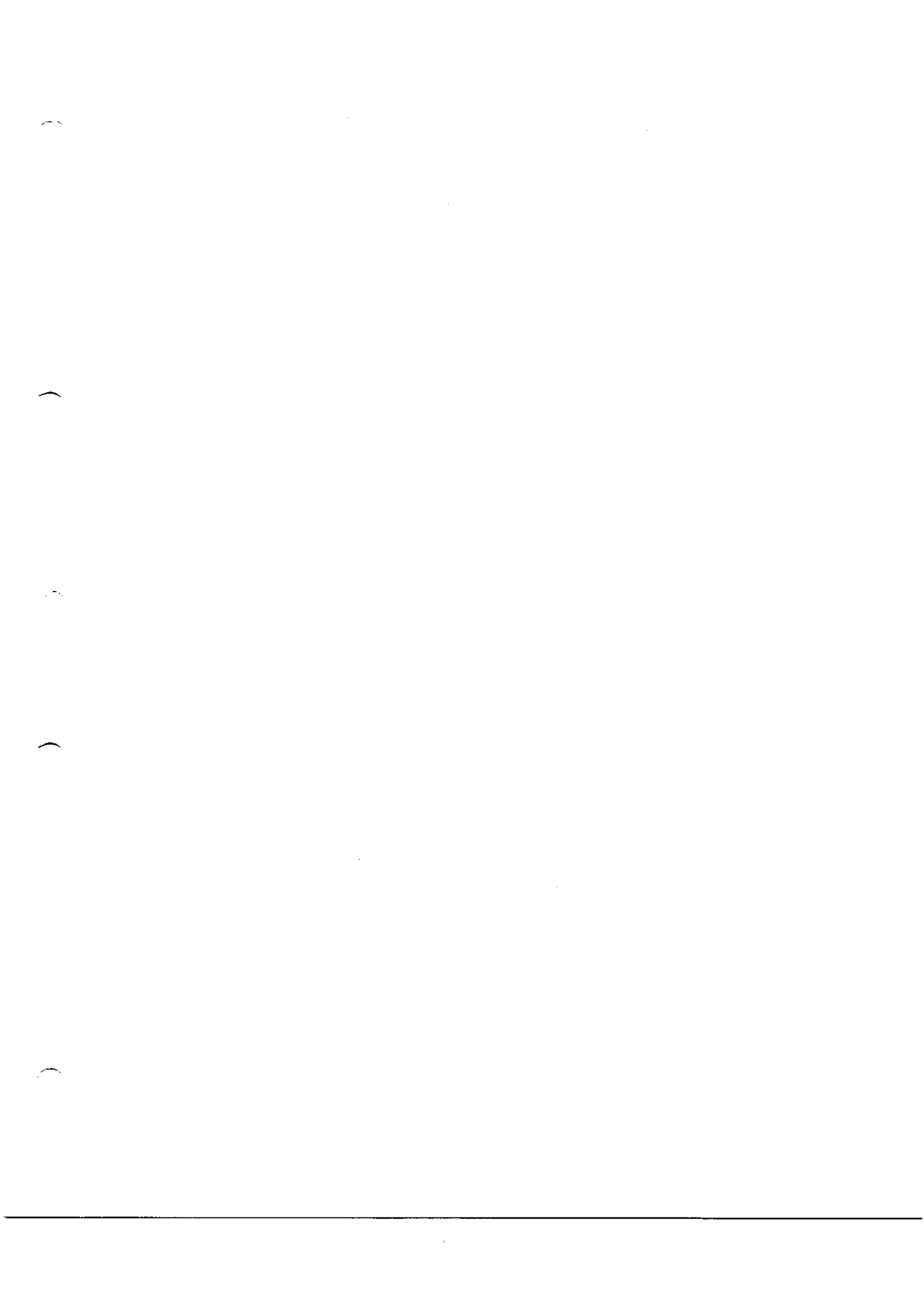

Trig Avionics Limited
Building 4, Heriot Watt Research Park
Riccarton, Currie EH14 4AP, UK

Tel: +44 (0)131 449 8810
Fax: +44 (0)131 449 8811

support@trig-avionics.com
www.trig-avionics.com



Deutscher Aero Club e.V.
Hermann-Blenkstr. 28
38108 Braunschweig

Petersen Aviation Inc.
Minden/NE, USA

Anhang zum Flughandbuch
für
PIPER-PA-28-140, PA-28-150, PA-28-151 Cherokee

Kennzeichen: **D-CE-DH4**

Werk-Nr.: **28-7415449**

Dieser Anhang muss dem offiziell genehmigten Flughandbuch des oben eingetragenen Flugzeug beigefügt sein, wenn das Flugzeug durch EMZ-Nr.: SA 1232 modifiziert wurde. Die in diesem Anhang enthaltenen Informationen ergänzen oder ersetzen diejenigen des Originalhandbuches nur in den folgenden Bereichen. Für Beschränkungen, Verfahren und Leistungsangaben, die in diesem Anhang nicht enthalten sind, ist das Originalhandbuch zu konsultieren.

Beschränkungen / Limitations

Kraftstoff: Zusätzlich zu den im Original-Flughandbuch aufgeführten Kraftstoffen sind folgende Kraftstoffe zugelassen:

Unverbleiter Automobilkraftstoff nach DIN EN 228 ROZ 98

Unverbleiter Automobilkraftstoff gemäß ASTM Spezifikation D-439 mit einem Antiknockindex von mindestens 91 Oktan (ROZ+MOZ)/2

Verbleiter Automobilkraftstoff gemäß ASTM Spezifikation D-439 mit einem Antiknockindex von mindestens 91 Oktan (ROZ+MOZ)/2

Das Mischen mit AVGAS Flugzeugkraftstoff ist gestattet.

Anmerkung: *Es dürfen nur Kraftstoffe mit einem Alkoholgehalt von maximal 1% verwendet werden! Falls diese Information nicht vorliegt bzw. dieser Kraftstoff nicht verfügbar ist, muss AVGAS getankt werden (entsprechend den Angaben des Flughandbuches).*

Kraftstoff nach DIN EN 228 kann bis zu 5 % Alkohol enthalten

Beschriftung: Neben den bestehenden AVGAS-Beschriftungen ist an jeder Tankeinfüllöffnung ein Aufkleber mit dem folgenden Text anzubringen:

Unverbleites Autobenzin
Minimum 98 ROZ
nach DIN EN 228 oder gemäß FAA
STC

Alkoholgehalt max 1 %
Mischen mit AVGAS gestattet

Vom Luftfahrt-Bundesamt genehmigt:



Datum: **17. Juni 02**

